

KENWOOD

MULTIPLE DVD/VCD/CD PLAYER

DV-705

DVF-R5070

INSTRUCTION MANUAL

KENWOOD CORPORATION



Before applying power

 **Caution : Read this page carefully to ensure safe operation.**





Units are designed for operation as follows.

- U.S.A. and Canada** **AC 120 V only**
- Europe** **AC 230 V only**
- Other countries** **AC 110 – 240 V**

Safety precautions

 **Caution : Read this page carefully to ensure safe operation.**

WARNING : TO PREVENT FIRE OR ELECTRIC SHOCK, DO NOT EXPOSE THIS APPLIANCE TO RAIN OR MOISTURE.

	<p>CAUTION RISK OF ELECTRIC SHOCK DO NOT OPEN</p>		<p>CAUTION: TO REDUCE THE RISK OF ELECTRIC SHOCK, DO NOT REMOVE COVER (OR BACK). NO USER-SERVICEABLE PARTS INSIDE. REFER SERVICING TO QUALIFIED SERVICE PERSONNEL.</p>
	<p>THE LIGHTNING FLASH WITH ARROWHEAD SYMBOL, WITHIN AN EQUILATERAL TRIANGLE, IS INTENDED TO ALERT THE USER TO THE PRESENCE OF UNINSULATED "DANGEROUS VOLTAGE" WITHIN THE PRODUCT'S ENCLOSURE THAT MAY BE OF SUFFICIENT MAGNITUDE TO CONSTITUTE A RISK OF ELECTRIC SHOCK TO PERSONS.</p>		
	<p>THE EXCLAMATION POINT WITHIN AN EQUILATERAL TRIANGLE IS INTENDED TO ALERT THE USER TO THE PRESENCE OF IMPORTANT OPERATING AND MAINTENANCE (SERVICING) INSTRUCTIONS IN THE LITERATURE ACCOMPANYING THE APPLIANCE.</p>		

The marking of products using lasers (For countries other than U.S.A. and U.S.-Military)



The marking this product has been classified as Class 1. It means that there is no danger of hazardous radiation outside the product.
Location: Back panel

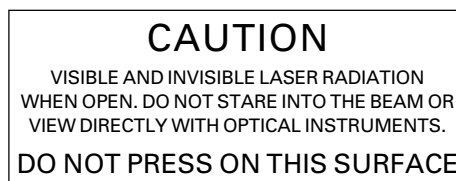

Inside this laser product, a laser diode classified as Class 2 laser radiation is contained as alerted by the internal caution label shown above. Do not stare into beam or view directly with optical instruments.
Location: DVD laser pick-up unit cover inside this product

Unpacking

Unpack the unit carefully and make sure that all the accessories are present.

If any accessories are missing, or if the unit is damaged or fails to operate, notify your dealer immediately. If the unit was shipped to you directly, notify your shipper immediately. Kenwood recommends that you retain the original carton and packing materials in case you need to move or ship the unit in the future.

Keep this manual handy for future reference.

Accessories

Please confirm that the following accessories are present.

Audio video cord (Red, White, Yellow) ... (1)

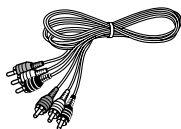

Remote control unit ... (1)

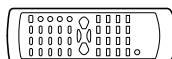

Batteries (R6/AA) ... (2)



Coaxial cable ... (1)

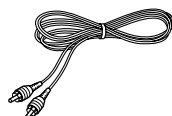

For the U.S.A.

CAUTION:

Use of controls or adjustments or performance of procedures other than those specified herein may result in hazardous radiation exposure.

In compliance with Federal Regulations, the following are reproductions of labels on, or inside the product relating to laser product safety.

KENWOOD CORPORATION
2967-3, ISHIKAWA-CHO,
HACHIOJI-SHI,
TOKYO, JAPAN

KENWOOD CORP. CERTIFIES THIS EQUIPMENT
CONFORMS TO DHHS REGULATIONS NO. 21 CFR
1040.10, CHAPTER 1, SUBCHAPTER J.

Location: Back Panel

CAUTION- LASER RADIATION WHEN OPEN.
DO NOT STARE INTO BEAM.

Location: Laser Pick-up Unit Cover inside this product

For the U.S.A.

FCC WARNING

This equipment may generate or use radio frequency energy. Changes or modifications to this equipment may cause harmful interference unless the modifications are expressly approved in the instruction manual. The user could lose the authority to operate this equipment if an unauthorized change or modification is made.

NOTE:

This equipment has been tested and found to comply with the limits for a Class B digital device, pursuant to Part 15 of the FCC Rules. These limits are designed to provide reasonable protection against harmful interference in a residential installation. This equipment may cause harmful interference to radio communications, if it is not installed and used in accordance with the instructions. However, there is no guarantee that interference will not occur in a particular installation. If this equipment does cause harmful interference to radio or television reception, which can be determined by turning the equipment off and on, the user is encouraged to try to correct the interference by one or more of the following measures:

- Reorient or relocate the receiving antenna.
- Increase the separation between the equipment and receiver.
- Connect the equipment into an outlet on a circuit different from that to which the receiver is connected.
- Consult the dealer or an experienced radio / TV technician for help.

Please read all of the safety and operating instructions before operating this appliance. Adhere to all warnings on the appliance and in the instruction manual. Follow all the safety and operating instructions. These safety and operating instructions should be retained for future reference.

1. Power sources – The appliance should be connected to a power supply only of the type described in the instruction manual or as marked on the appliance. If you are not sure of the type of power supply to your home, consult your appliance dealer or local power company. For appliances intended to operate from battery power, or other sources, refer to the instruction manual.

2. Power-cord protection – Power-supply cords should be routed so that they are not likely to be walked on or pinched by items placed upon or against them, pay particular attention to cords at plugs, convenience receptacles, and the point where they exit from the appliance.

Never pull or stretch the cord.

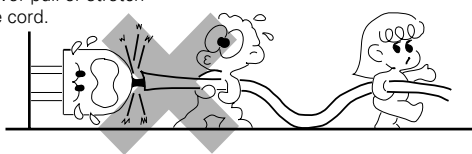

3. CAUTION – Polarization – This appliance may be equipped with a polarized alternating-current line plug (a plug having one blade wider than the other). This plug will fit into the power outlet only one way. This is a safety feature. If you are unable to insert the plug fully into the outlet, try reversing the plug. If the plug should still fail to fit, contact your electrician to replace your obsolete outlet. Do not defeat the safety purpose of the polarized plug.

4. Ventilation – Slots and openings in the cabinet are provided for ventilation and to ensure reliable operation of the appliance and to protect it from overheating, and these openings must not be blocked or covered. The appliance should be situated so that its location or position does not interfere with its proper ventilation.

To maintain good ventilation, do not put records or a tablecloth on the appliance. Place the appliance at least 10 cm away from the walls.

Do not use the appliance on a bed, sofa, rug or similar surface that may block the ventilation openings. This appliance should not be placed in a built-in installation such as a bookcase or rack unless proper ventilation is provided or the manufacturer's instructions have been adhered to.

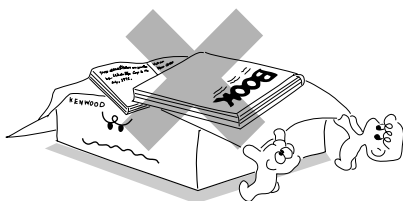

5. Water and moisture – The appliance shall not be exposed to dripping and splashing—for example, near a bathtub, washbowl, kitchen sink, laundry tub, in a wet basement, or near a swimming pool, etc. Do not place an object containing liquid, such as a flower vase, on the appliance.

6. Temperature – The appliance may not function properly if used at extremely low, or freezing temperatures. The ideal ambient temperature is above +5°C (41°F).

7. Heat – The appliance should be situated away from heat sources such as radiators, heat registers, stoves, or other appliances (including amplifiers) that produce heat. Do not place a flaming object, such as a candle or lantern, on or near the appliance.

8. Electric shock – Care should be taken so that objects do not fall and liquid is not spilled into the enclosure through openings. If a metal object, such as a hair pin or a needle, comes into contact with the inside of this appliance, a dangerous electric shock may result. For families with children, never permit children to put anything, especially metal, inside this appliance.

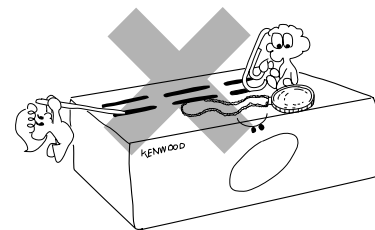

9. Enclosure removal – Never remove the enclosure. If the internal parts are touched accidentally, a serious electric shock might occur.

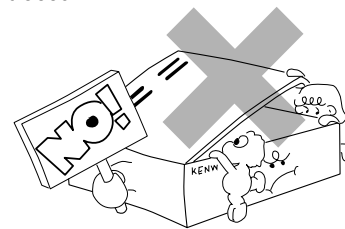

10. Magnetic fields – Keep the appliance away from sources of magnetic fields such as TV sets, speaker systems, radios, motorized toys or magnetized objects.

11. Cleaning – Unplug this appliance from the wall outlet before cleaning. Do not use volatile solvents such as alcohol, paint thinner, gasoline, or benzene, etc. to clean the cabinet. Use a clean dry cloth.

12. Accessories – Do not place this appliance on an unstable cart, stand, tripod, bracket, or table. The appliance may fall, causing serious injury to a child or adult, and serious damage to the appliance. Use only with a cart, stand, tripod, bracket, or table recommended by the manufacturer, or sold with the appliance. Any mounting of the appliance should follow the manufacturer's instructions, and should use a mounting accessory recommended by the manufacturer. An appliance and cart combination should be moved with care. Quick stops, excessive force, and uneven surfaces may cause the appliance and cart combination to overturn.



13. Lightning – For added protection for this appliance during a lightning storm, or when it is left unattended and unused for long periods of time, unplug it from the wall outlet and disconnect the antenna or cable system. This will prevent damage to the appliance due to lightning and power-line surges.

14. Abnormal smell – If an abnormal smell or smoke is detected, immediately turn the power OFF and unplug the appliance from the wall outlet. Contact your dealer or nearest service center.

POWER OFF!

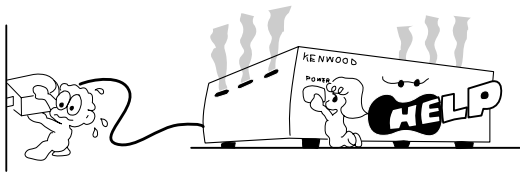

15. Damage requiring service – The appliance should be serviced by qualified service personnel when:

- A.** The power-supply cord or the plug has been damaged.
- B.** Objects have fallen, or liquid has been spilled into the appliance.
- C.** The appliance has been exposed to rain or water.
- D.** The appliance does not appear to operate normally by following the instruction manual. Adjust only those controls that are covered by the instruction manual as an improper adjustment of other controls may result in damage and will often require extensive work by a qualified technician to restore the appliance to its normal operation.
- E.** The appliance has been dropped, or the enclosure damaged.
- F.** The appliance exhibits a marked change in performance.

16. Servicing – The user should not attempt to service the appliance beyond that described in the instruction manual. All other servicing should be referred to qualified service personnel.

17. Outdoor antenna grounding– If an outside antenna is connected to the appliance, be sure the antenna system is grounded so as to provide some protection against voltage surges and built up static charges. Article 810 of the National Electrical Code ANSI/NFPA 70, provides information with respect to proper grounding of the mast and supporting structure, grounding of the lead-in wire to an antenna discharge unit, size of grounding conductors, location of antenna discharge unit, connection to grounding electrodes, and requirements for the grounding electrode. See Figure.

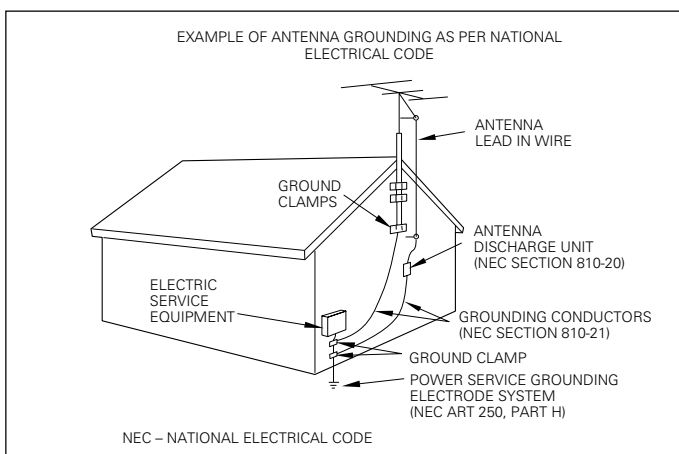

18. Power lines – An outside antenna system should not be located in the vicinity of overhead power lines or other electric light or power circuits, or where it can fall into such power lines or circuits. When installing an outside antenna system, extreme care should be taken to keep from touching such power lines or circuits as contact with them might be fatal.

19. AC outlets – Do not connect other audio equipment with a power consumption larger than that specified to the AC outlet on the rear panel. Never connect other electrical appliances, such as an iron or toaster, to it to prevent fire or electric shock.

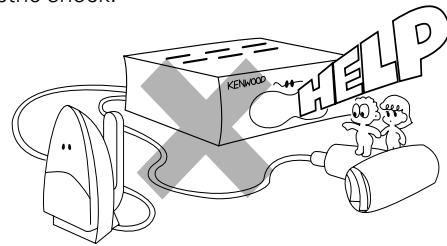

20. Overloading – Do not overload wall outlets, extension cords, or integral convenience receptacles as this can result in a risk of fire or electric shock.

21. Attachment – Do not use attachments not recommended by the appliance manufacturer as they may cause hazards.

22. Replacement parts–When replacement parts are required, be sure the service technician has used replacement parts specified by the manufacturer or have the same characteristics as the original parts. Unauthorized substitutions may result in fire, electric shock, or other hazards.



23. Safety check – Upon completion of any service or repairs to this appliance, ask the service technician to perform safety checks to determine that the appliance is in proper operating condition.

Notes:

1. Item 3 is not required except for grounded or polarized equipment.
2. Item 17 and 18 are not required except for units provided with antenna terminals.
3. Item 17 complies with UL in the U.S.A.

Special features

This document classifies the applications of each feature using the following marks.

-  : Description of a feature that can be used with DVD.
-  : Description of a feature that can be used with CD.
-  : Description of a feature that can be used with VCD.

 **Higher video quality than S-VHS video and LaserDisc**

 **Higher audio quality than music CD**



   **On screen Display (OSD)**

MP3 and JPEG files playback

Contents

Caution : Read the pages marked  carefully to ensure safe operation.

Preparations

Introduction	2
 Before applying power	2
 Safety precautions	2
 IMPORTANT SAFEGUARDS	4
Special features and Contents	6
Special features	6
Contents	6
Discs information	7
Types of playable discs	7
Unplayable discs	7
Icons on the DVD VIDEO discs	7
Region Codes	8
Region codes in the world	8
Video formats	9
Important items	10
Maintenance	10
Reference	10
System Connections	11
Connecting to a TV with video (composite) input terminal	11
Connecting to a TV with S-video input terminal	11
Connecting to a TV with SCART input terminal (For Europe and U.K.)	11
Connecting to a TV with Component input terminals (For some areas)	12
Connecting to an Audio component	12
Controls and indicators	13
Operation of remote control unit	14
Set Up functions	16
Select OSD Language	19
Select Audio Language	19
Select Subtitle Language	20
Select Menu Language	20
Select Audio Output	21
Select LPCM Output	21
Select TV Screen	22
Select progressive Mode (for U.S.A., Canada and U.S. Military)	22
Select Video output (for Europe and Australia)	23
Select Color Scheme	23
Set the Custom Color	24

Select Picture slide scale	24
Select Rating level	25
Change Password	25
Put back to the Default Setting	26
DVD menu language list	26

Operations

Playback of disc	27
Basic play	27
Disc playback features	28
On screen display	30
Various playback functions	31
Select Audio Language	31
Select the Audio channel	31
Select Subtitle Language	31
Select Subtitle on or off	31
Select Camera angle	32
Random play	32
Repeat play	33
A-B Repeat play	33
Using Bookmarks	34
Program play	35
Menu playback	38
Hierarchical structure of VCD menus	38
Playback without using the menu playback function (In case of a P.B.C.-compatible VCD) (To P.B.C. On or Off)	39
MP3 /JPEG media playback	40
Guidance of MP3/JPEG	40
Playing back MP3/JPEG files	41
Selects the files to be played back directly	40
Rotating a picture (JPEG files only)	42
MP3/JPEG Repeat play	42
MP3/JPEG Random play	43
ZOOM function (only for JPEG files)	43
MP3/JPEG program playback	44

Knowledge

In case of difficulty	45
Specifications	47

Types of playable discs

The system using this unit does not only play music from CD but can also play the discs listed below to offer you high-quality entertainment of video of movies and live concerts.

Playable Disc		DVD VIDEO		CD (CD-R, CD-RW)		VCD (SVCD*)	
Logo mark on disc							
Disc size							
Played sides		One or both	One or both	One side only	One side only	One side only	One side only
Contents	Video + Audio	Approx. 41 min. (1 side, 1 layer) Approx. 75 min. (1 side, 2 layers) Approx. 82 min. (2 sides, 1 layer) Approx. 150 min. (2 sides, 2 layers)	Approx. 133 min. (1 side, 1 layer) Approx. 242 min. (1 side, 2 layers) Approx. 266 min. (2 sides, 1 layer) Approx. 484 min. (2 sides, 2 layers)	/	/	Max. 20 min.	Max. 74 min.
	Audio					Max. 20 min., digital	Max. 80 min., digital

MP3 media and JPEG picture CD those can be played back with this equipment (CD-R, CD-RW) → 40

- * This unit can play SVCDs, but some functions will not work.
- This unit can play DVD-R, DVD+R, DVD-RW, and DVD+RW discs, but depending on the recording unit, the disc manufacturer, etc., playback sometimes may not be possible.
When a disc recorded in low-quality mode is played back, the picture may flicker or show other defects. In such a case, record again in high-quality mode.
- This unit may also be incapable of playing certain CD-R/RW discs depending on their properties, recording conditions, etc.

Unplayable discs

This player cannot play back any of the following discs.

<p>DVD AUDIO discs DVD-ROM discs DVD-RAM discs SACD discs CD-ROM discs (Except MP3 and JPEG discs [ISO 9660 level 1])</p> <ul style="list-style-type: none"> ● A DVD VIDEO disc with a region code which does not match this unit or without a region code. For details, see "Region Codes". → 8 ● When the video format of a disc differs from that of the TV in use, the disc cannot be played normally. For details, see "Video Formats". → 9 	<p>VSD discs CDV discs (Only the audio part can be reproduced.) CD-G/CD-EG/CD-EXTRA discs (Only the audio can be reproduced.) Photo CD discs (Never attempt to play them.)</p>
---	---

Icons on the DVD VIDEO discs

Icon	Description
	Indicates the region code where the disc can be played.
	Number of voice languages recorded with the audio function. The number in the icon indicates the number of voice languages. (Max. 8 languages)
	Number of subtitle languages recorded with the subtitle function. The number in the icon indicates the number of subtitle languages. (Max. 32 languages)
	Number of angles provided by the angle function. The number in the icon indicates the number of angles. (Max. 9 angles)
	Aspect ratios that can be selected. "4 : 3 LB" stands for Letter Box and "4 : 3 PS" for Pan/Scan. → 17 In the example on the left, the 16:9 video can be converted into letter box video.

Every player of this model has a certain region code assigned to it based on the country where the player is used. When the player is used to play back DVD VIDEO discs, it can only play the DVD VIDEO discs carrying the region codes matching the region code of the player.

The region code for this player is described on the rear panel of the player.

Region codes in the world

The DVD players are given a region code according to the country or area it is marketed, as shown in the following map.

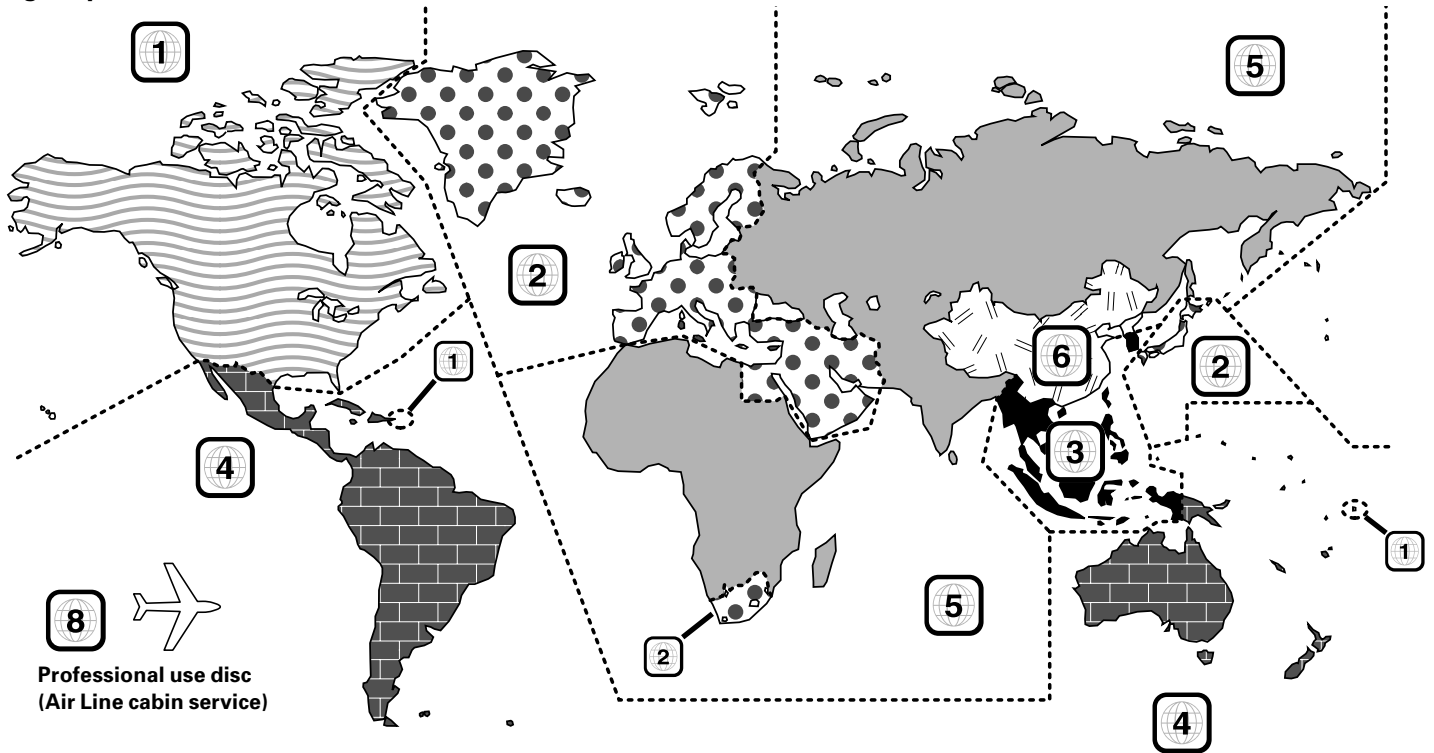

Region codes of the DVD VIDEO discs that can be played with this player

This player can play back a DVD VIDEO disc which carries the corresponding code to the region code of the player shown in the table above, a marking containing the region code of the player or the "ALL" marking shown below. Even when a DVD VIDEO disc does not carry any indication of the region code, it may sometimes be unable to be played on this player due to certain restrictions.



Restrictions due to difference between discs

Some DVD and VCD discs can be played only in certain playback modes according to the intentions of the software producers. As this player plays discs according to their intentions, some functions may not work as intended by you. Please be sure to read the instructions provided with each disc. When an inhibition icon is displayed on the TV screen connected to the player, it indicates that the disc being played is under the restriction as described above.

Inhibition icon



The TV picture display and disc signal systems can be divided roughly into two TV formats (NTSC and PAL).

They are variable depending on countries and areas.

TV Format	Major Countries & Areas
NTSC	Japan, Taiwan, Korea, USA, Canada, Mexico, Philippines, Chile, etc.
PAL	China, U.K., Germany, Australia, New Zealand, Kuwait, Singapore, etc.

(For Europe)

This unit has a function for changing the video format according to the TV type. The initial setting of this unit for "TV Type" is PAL. Please confirm the type of your TV.

(For other countries)

This unit has a function for changing the video format according to the TV type. The initial setting of this unit for "TV Type" is NTSC. Please confirm the type of your TV.

Checking the Video Format ("Preparation for Set Up" →)

Check the video format of the TV to be used

When the video formats are different :

Try playing the disc. If the video formats of the disc and TV do not match, the played video may be black and white or become as shown below.

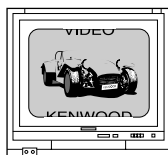

Top and bottom edges are not displayed.

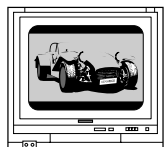

Top and bottom areas are dark.

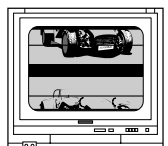

Picture turbulence due to sync unmatching.

Maintenance

Maintenance of the unit

When the front panel or case becomes dirty, wipe with a soft, dry cloth. Do not use thinner, benzine, alcohol, etc. for these agents may cause discoloration.

In regard to contact cleaner

Do not use contact cleaners because it could cause a malfunction. Be specially careful not to use contact cleaners containing oil, for they may deform the plastic component.

Reference

Disc handling precautions

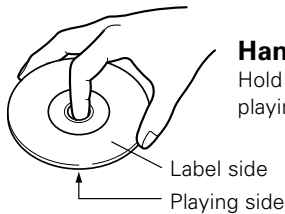

Handling

Hold the disc so that you do not touch the playing surface.

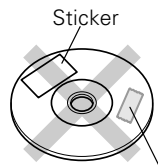

Do not attach paper or tape to either the playing side or the label side of the disc.

Sticky paste

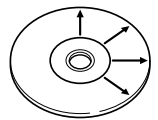

Cleaning

If there are fingerprint marks or foreign matter found on the disc, lightly wipe the disc with a soft cotton cloth (or similar) from the center of the disc outwards in a radial manner.

Storage

When a disc is not to be played for a long period of time, remove it from the player and store it in its case.

Never play a cracked or warped disc

During playback, the disc rotates at high speed in the player. Therefore, to avoid danger, never use a cracked or deformed disc or a disc repaired with tape or adhesive agent. Please do not use discs which are not round because they may cause malfunction.

Disc accessories

The disc accessories (stabilizer, protection sheet, protection ring, etc.) which are marketed for improving the sound quality or protecting discs as well as the disc cleaner should not be used with this system because they may cause malfunction.

Note related to transportation and movement

Before transporting or moving this unit, carry out the following operations.

1. Set the **POWER ON/OFF** switch to the **ON** without loading a disc.
2. Wait a few seconds and verify that the display shown appears.

NO DISC

3. Set the **POWER ON/OFF** switch to **OFF**.

Caution on condensation

Condensation (of dew) may occur inside the unit when there is a great difference in temperature between this unit and the outside. This unit may not function properly if condensation occurs. In this case, leave the unit for a few hours and restart the operation after the condensation has dried up.

Be specially cautious against condensation in the following circumstances:

When this unit is carried from one place to another across a large difference in temperature, when the humidity in the room where this unit is installed increases, etc.

Make connections as shown below.
When connecting the related system components, refer also to the instruction manuals of the related components.

Caution:
Do not plug in the power lead until all connections are completed.

Malfunction of microcomputer

If operation is not possible or erroneous display appears even though all connections have been made properly, reset the microcomputer referring to "In case of difficulty". → 45

CAUTION

Be sure to adhere to the following, or proper ventilation will be blocked causing damage or fire hazard.

- Do not place any objects impairing heat radiation onto the top of the unit.
- Leave some space around the unit (from the largest outside dimension including projection) equal to or greater than, shown below.

Top panel : 50 cm Side panel : 10 cm Back panel : 10 cm

Connecting to a TV with video (composite) input terminal

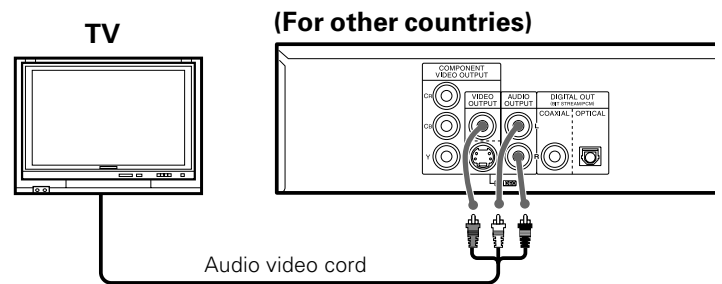
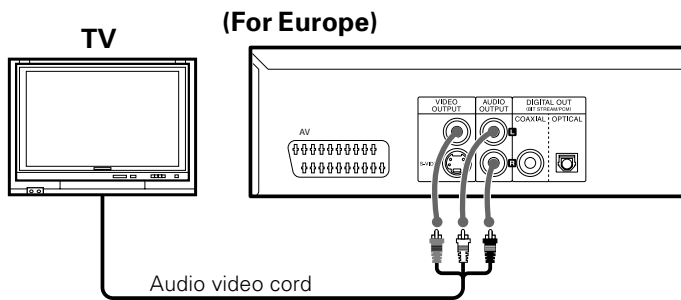

Connecting to a TV with S-video input terminal

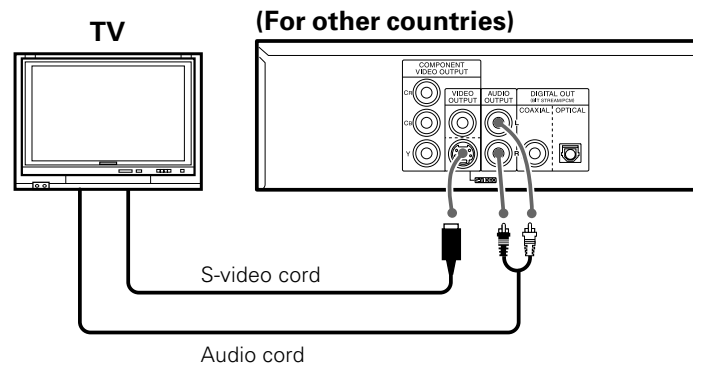
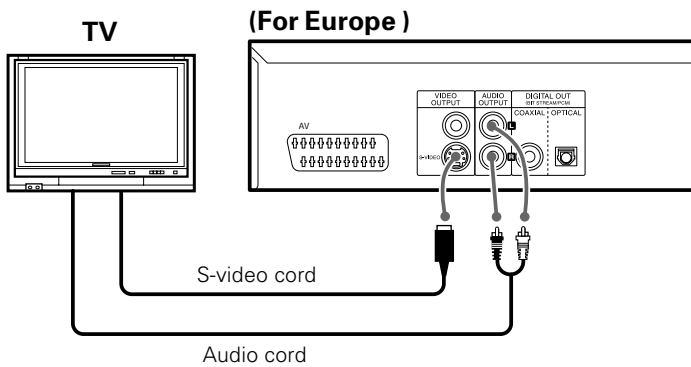

Connecting to a TV with SCART input terminal (For Europe)

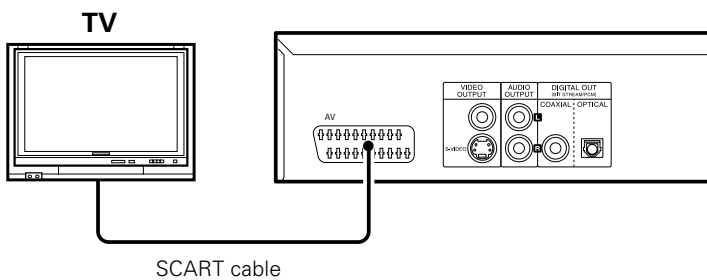

DTS disclaimer clause

When playing DTS-encoded (CDs, LDs, DVDs), excessive noise will be exhibited from the analog stereo outputs. To avoid possible damage to the audio system, the consumer should take proper precautions when the analog stereo outputs of the DVD player is connected to an amplification system.

To enjoy DTS Digital Surround™ playback, an external 5.1 channel DTS Digital Surround™ decoder system must be connected to the digital output (S/P DIF, AES/EBU, or TosLink) of the DVD player.

Connecting to a TV with Component input terminals (For some countries)

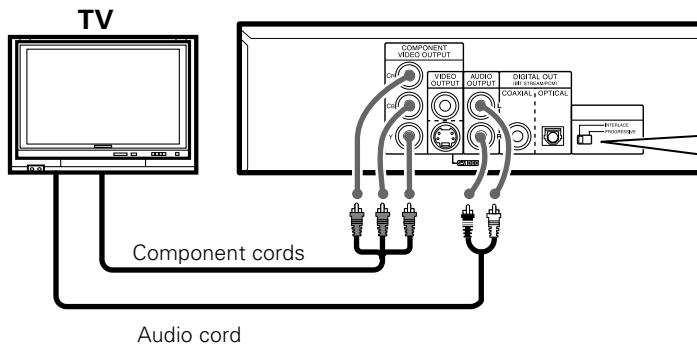

[For U.S.A., Canada and U.S. Military]

Select the scanning method of the Component Video output using the COMPONENT VIDEO OUTPUT switch on the rear panel.

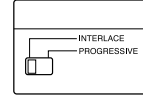

INTERLACE: Scanning method is fixed at interlaced scanning.

PROGRESSIVE: When progressive scanning is unavailable with certain discs, the scanning method is switched automatically to interlaced scanning. When the scanning method is changed, the scanning status will be displayed for a few seconds.



Please note that when **PROGRESSIVE** is selected, only **COMPONENT VIDEO OUTPUT** is available, while other video output is not present.

Connecting to an Audio component

For playback of DTS audio, please connect an AV receiver or an AV amplifier which can decode DTS by digital connection.

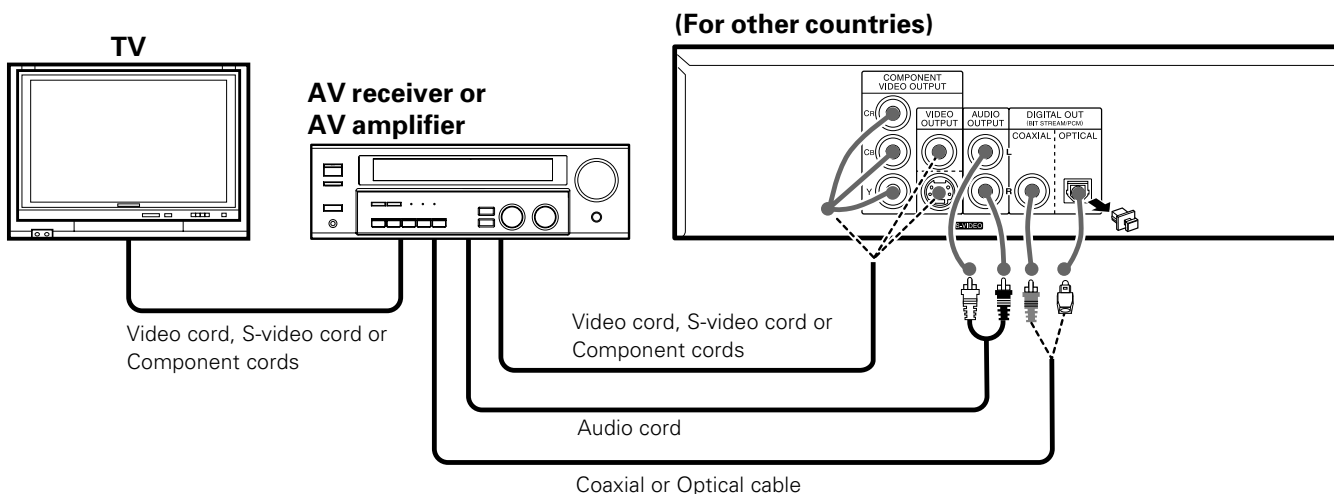
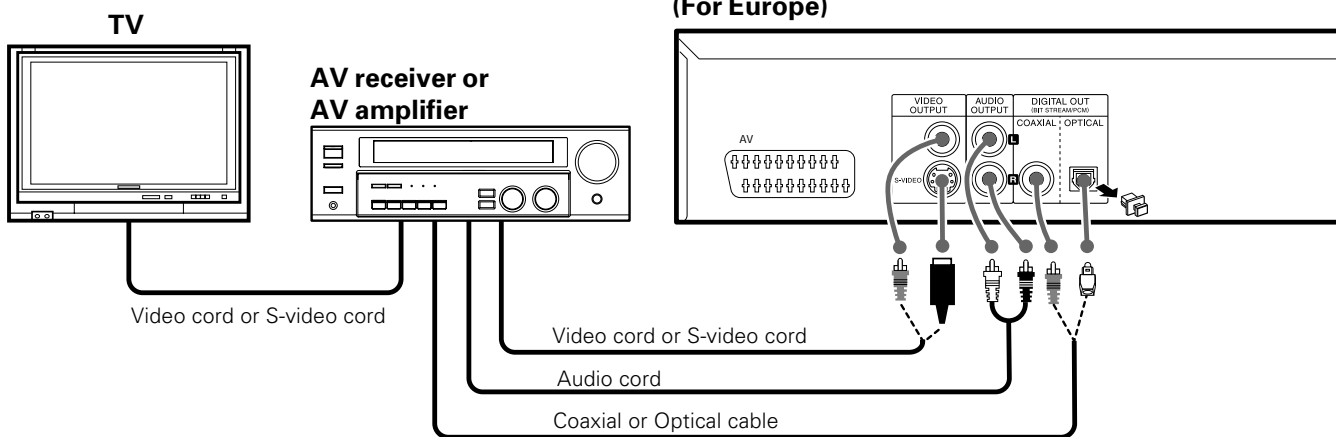

1. In case an associated system component is connected, also read the instruction manual of the component.
2. Insert the optical-fiber cable straight into the connector until it clicks.
3. Never bend or bundle the optical-fiber cable.

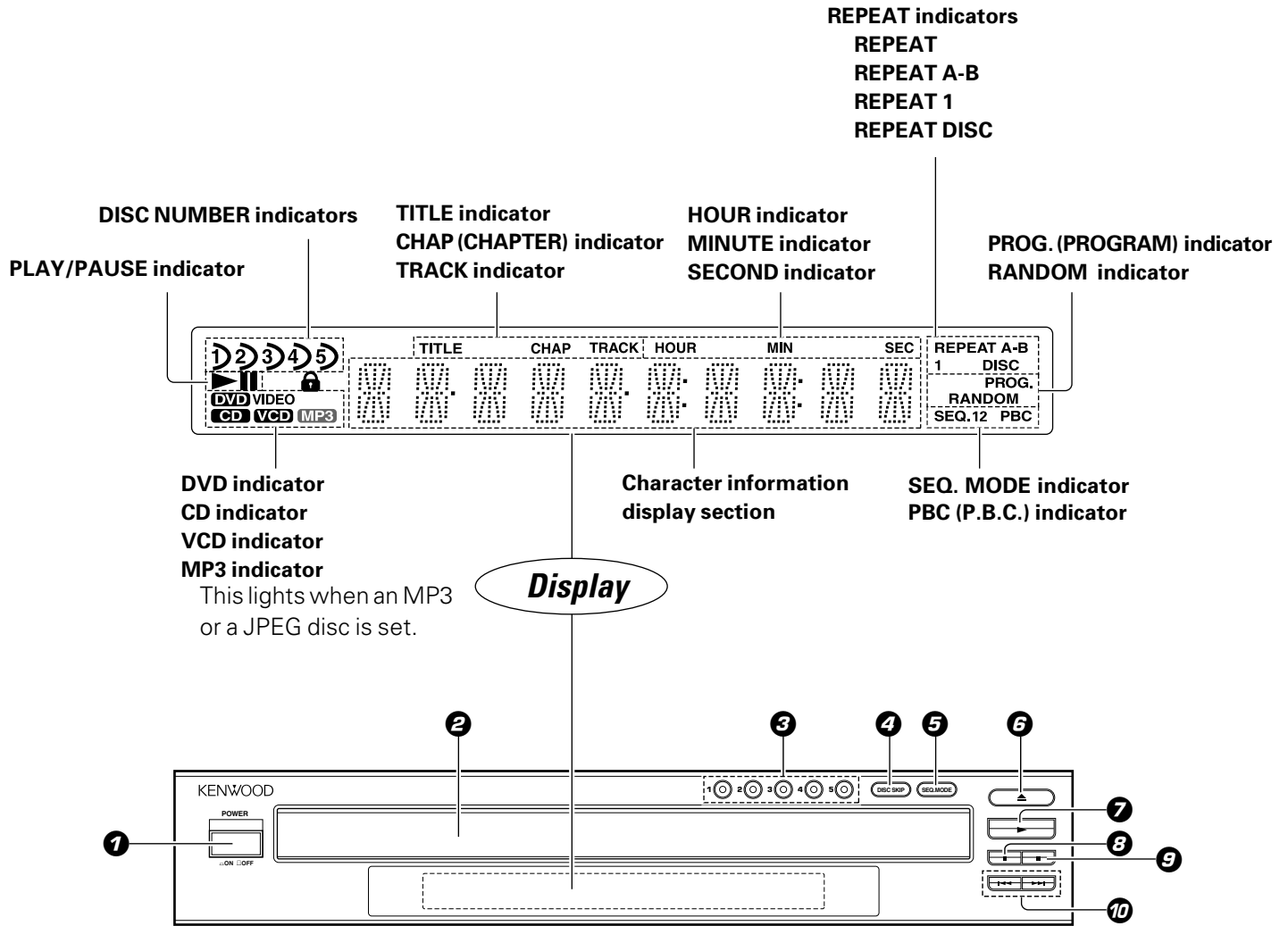

- ① POWER ON / OFF switch - 27
- ② Disc tray - 27
- ③ Disc 1 ~ Disc 5 keys/indicators - 29
- ④ DISC SKIP key - 29
- ⑤ SEQ. (SEQUENCE) MODE key - 29
- ⑥ ▲ (Open/Close) key - 27
- ⑦ ► (Play) key - 27
- ⑧ || (Pause) key - 27
- ⑨ ■ (Stop) key - 27
- ⑩ ◀◀(PREV.), ▶▶(NEXT) (Skip) keys - 28

CAUTION

The power in this equipment will not be completely cut off from the AC wall outlet when the main switch is turned OFF.

DIMMER function

The display brightness of the main unit can be changed.

DIMMER



Switching as shown below is done each time the DIMMER key on the remote control is pressed.

- ① Dim 1
- ② Dim 2
- ③ Bright

The keys on the remote control unit with the same names as on the main unit have the same function as the keys on the main unit.

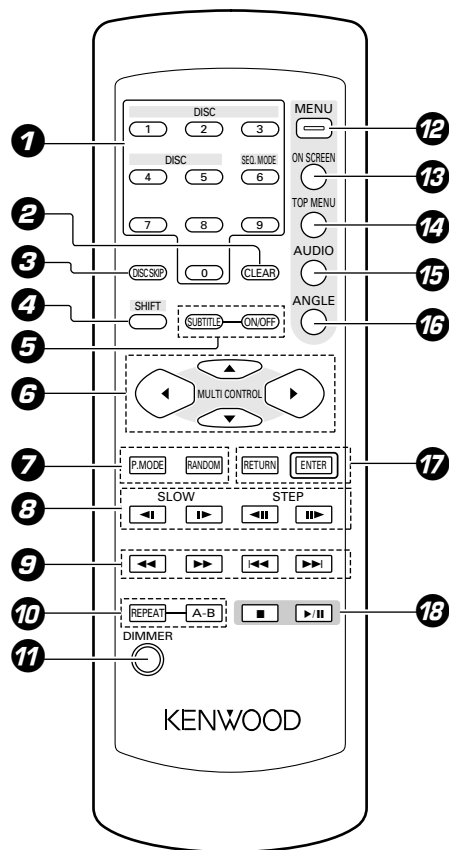

Model : RC-D0308 (Infrared ray system)

- ① Numeric keys → 19 → 20
- ② CLEAR key
- ③ DISC SKIP key → 27 → 29
- ④ SHIFT key → 29
- ⑤ SUBTITLE key (SUBTITLE) ON/OFF key → 31
- ⑥ Cursor Up (▲), Down (▼), Left (◀) and Right (▶) keys → 19 ~ 25, → 35 → 36
- ⑦ P.MODE key (RANDOM) key → 35 → 44
- ⑧ SLOW (Back slow/ Forward slow) keys → 28
- STEP (Back step/ Forward step) keys → 28
- ⑨ ◀◀ key/▶▶ key (Search key) → 28
- ◀◀ (PREV.) key/▶▶ (NEXT) key (Skip key) → 28
- ⑩ REPEAT key → 33 → 42
- A-B Repeat key → 33
- ⑪ DIMMER key → 13
- ⑫ MENU key → 19 ~ 25
- ⑬ ON SCREEN key → 30
- ⑭ TOP MENU key → 27
- ⑮ AUDIO key → 31
- ⑯ ANGLE key → 32
- ⑰ RETURN key → 24 → 25
- ENTER key → 19 → 25 → 34 → 35 → 41 → 44
- ⑱ ■ (Stop) key → 27
- ▶/|| (Play/Pause) key → 27

Loading batteries

① Remove the cover.

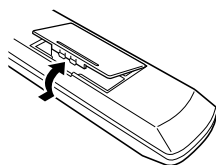

② Insert batteries.

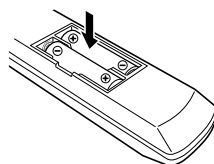

- Insert two R6/LR6 ("AA"-size) batteries following the polarity indications.

③ Close the cover.

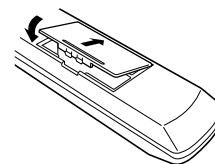

Operation

Insert the power plug into a power outlet, press the POWER ON/OFF switch of the main unit to ON, then press the desired remote control key.

- When pressing more than one remote control keys successively, press the keys securely by leaving an interval of 1 second or more between pressing of keys.

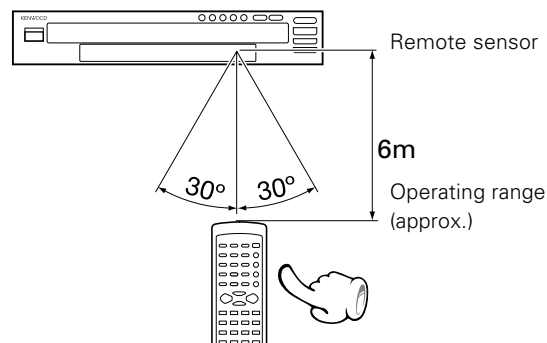

1. The provided batteries are intended for use in operation checking, and their service life may be short.
2. When the remote controllable distance becomes short, replace both of the batteries with new ones.
3. If direct sunlight or the light of a high-frequency fluorescent lamp (inverter type, etc.) is incident to the remote sensor, malfunction may occur. In such a case, change the installation position to avoid malfunction.



Preparation for Set Up

① Set the **POWER ON/OFF** switch to the **ON** () position.

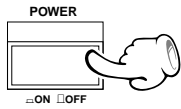

- After the power is switched ON, there is a delay of about 3 seconds before the display is lit.

② Set TV Format according to the connected TV type.

(Initial Settings →)

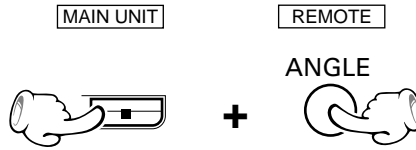

With no disc inserted, keep the **ANGLE** key on the remote control pressed and press the **STOP** key on the main unit. Each time the **STOP** key is pressed, the setting will be switched as follows.

- ① NTSC
- ② MULTI (NTSC/PAL switchable)
- ③ PAL

Set up menu

The **SETUP** functions are the following diverse functions. Please change them according to your use environment.

Language Set up

OSD Language

This switches the language for the on-screen display. ()

Audio Language*

Choose the language for the **AUDIO** output. ()

Subtitle Language*

Choose the language for **SUB TITLE**. ()

Menu Language*

Choose the language for the menu recorded on the DISC. ()

* When "**Original**" is selected for items marked with an asterisk (*), automatic switching to the language initially set for the disc will be done.

Please refer to Page 26 for the languages compatible with this model.

Audio Set up

Digital Output

This selects the format of the audio output from the **DIGITAL OUT** terminal.

BitStream

Choose this when connecting to an amplifier with built-in Dolby digital or DTS decoder.
When a DVD recorded with Dolby digital or DTS is played back, a bitstream signal will be put out.
When a disc recorded with linear PCM is played back, a linear PCM signal will be put out.

LPCM

Choose this for PCM output.
When a DVD recorded with Dolby digital is played back, output will be made converted to 2-channel PCM.
And when a DVD recorded with DTS is played back, a bitstream signal will be put out.

LPCM Output

This selects the clock frequency for linear PCM output.

96kHz

In case of 96 kHz digital signal, DVD will deliver 96 kHz signal out. In this case your receiver should control 96 kHz signal.

48kHz

Sets the linear PCM output to 48 kHz.
Even in case of 96 kHz digital signal, DVD will deliver 48 kHz signal out.

The items in are the initial set values.

How to use the RETURN key

When the **RETURN** key is pressed, the display returns to the previous screen (**STOP** mode).



Video Set up

TV Screen

This sets the screen size (4:3 or 16:9 aspect ratio) according to the connected TV.

4 : 3 LB

Choose this setting if you would prefer to see movies in their original aspect ratio. You will see the entire frame of the movie, but it will occupy a smaller portion of the screen. This setting may result in the movie appearing with black bars at the top and bottom of the screen.

4 : 3 PS

Choose this setting if you want the movie to fill the entire screen of your TV. You won't see part of the picture (particularly the right and left edge).

Some disc produced in a wide screen format can't be cropped in this fashion, which means the black bars would appear at the top and the bottom of the screen.

16 : 9

Choose this setting if your DVD player is connected to a widescreen TV.

Progressive Mode (For U.S.A., Canada and U.S. Military)

The method for conversion of an interlaced signal to a progressive signal can be selected.

AUTO

Switching between **WEAVE** and **BOB** shown below is done automatically according to the video contents of the disc.

WEAVE

This method combines two fields to convert them to one frame. This is effective for playback of animations created on a computer etc.

BOB

This method interpolates the missing lines above and below a field for conversion to a single frame. This is effective for images other than those for which the above **WEAVE** is recommended.

Video output (For Europe)

Choose "S-VIDEO" in case of connection to the **S-VIDEO** terminals on the rear, choose "**RGB**" in case of connection to the **AV** terminal. Output will not be made to the not selected terminals (→11) (**S-VIDEO**)

Color Scheme

Color adjustment can be performed.

Standard

This is the standard setting.

Best

This mode is an experienced combination of contrast, color, luminance.

Soft

A soft coloring will be obtained.

Sharp

A sharp coloring will be obtained.

Customed

Chose this setting to use values set in detail for a custom color setting.

Custom Color

Fine setting of the color composition elements is possible.

Fine adjustment is possible for brightness, contrast, saturation, and sharpness.

System Set up

Picture slide scale

The display scale at the time of playback of a JPEG file slide show can be selected.

Fixed

Use is made with fixed scale.

Automatic

Display is made with automatic size change to match the size of the TV screen.

Rating Level

This can restrict playback of adult-oriented DVD discs that you do not want to be seen by children. However, even when a DVD disc is marked "Adult-oriented" or so on the label, its viewing cannot be restricted unless the restriction level is recorded in the disc itself. (**8**)

Parental lock level;

Level 8: All DVDs can be played back.(Factory preset)

Level 7 to 2: DVDs for general audiences/children can be played back. (DVDs for adults are prohibited.)

Level 1: DVDs for children can be played back. (DVDs for adults/general audiences are prohibited.)

Password input is required for setting or changing of the rating level.

(The password set at the time of shipping from the factory is "0000".)

Restore Setup Info

This resets all settings, except for **PARENTAL** and **PASSWORD**, to the factory defaults.

Please refer to pages 16 to 18 for setup.

DVD Select OSD Language

- 1 During stop mode, press MENU key on the remote.

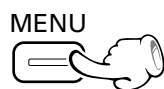

- 2 Press Cursor up/down (▲/▼) keys on the remote to select the "Language" icon, then press Cursor right (▶) key.



- 3 Press Cursor up/down (▲/▼) keys on the remote to select "OSD Language", then press the Cursor right (▶) key to access the sub features



- 4 Press Cursor up/down (▲/▼) keys on the remote to select specific language, then press the ENTER key.

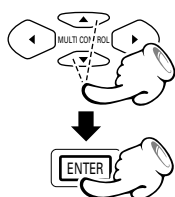

- 5 Press Cursor left (◀) key on the remote to return to previous menu.



- 6 Press the MENU key to return to previous display.



DVD Select Audio Language

- 1 During stop mode, press MENU key on the remote.



- 2 Press Cursor up/down (▲/▼) keys on the remote to select the "Language" icon, then press Cursor right (▶) key.

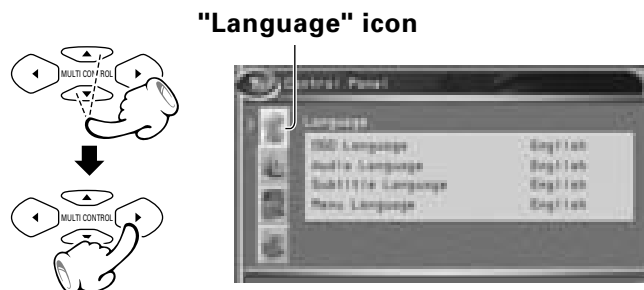

- 3 Press Cursor up/down (▲/▼) keys on the remote to select "Audio Language", then press the Cursor right (▶) key to access the sub features



- 4 Press Cursor up/down (▲/▼) keys on the remote to select specific language, then press the ENTER key.

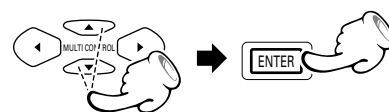

When "Original" is selected, automatic switching to the language initially set for the disc to be played back will be done.

Please refer to Page 26 for the languages compatible with this model.

- 5 Press Cursor left (◀) key on the remote to return to previous menu.



- 6 Press the MENU key to return to previous display.



Please refer to pages 16 to 18 for setup.

DVD Select Subtitle Language

- ① During stop mode, press MENU key on the remote.

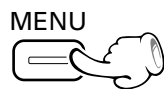

- ② Press Cursor up/down (▲/▼) keys on the remote to select the "Language" icon, then press Cursor right (▶) key.



- ③ Press Cursor up/down (▲/▼) keys on the remote to select "Subtitle Language", then press the Cursor right (▶) key to access the sub features.



- ④ Press Cursor up/down (▲/▼) keys on the remote to select specific language, then press the ENTER key.

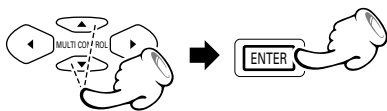

When "Original" is selected, automatic switching to the language initially set for the disc to be played back will be done.

Please refer to Page 26 for the languages compatible with this model.

- ⑤ Press Cursor left (◀) key on the remote to return to previous menu.



- ⑥ Press the MENU key to return to previous display.



DVD Select Menu Language

- ① During stop mode, press MENU key on the remote.

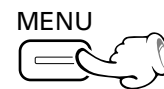

- ② Press Cursor up/down (▲/▼) keys on the remote to select the "Language" icon, then press Cursor right (▶) key.



- ③ Press Cursor up/down (▲/▼) keys on the remote to select "Menu Language", then press the Cursor right (▶) key to access the sub features



- ④ Press Cursor up/down (▲/▼) keys on the remote to select specific language, then press the ENTER key.

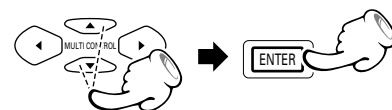

When "Original" is selected, automatic switching to the language initially set for the disc to be played back will be done.

Please refer to Page 26 for the languages compatible with this model.

- ⑤ Press Cursor left (◀) key on the remote to return to previous menu.



- ⑥ Press the MENU key to return to previous display.



Please refer to pages 16 to 18 for setup.

DVD Select Audio Output

- 1 During stop mode, press MENU key on the remote.



- 2 Press Cursor up/down (▲/▼) keys on the remote to select the "Audio" icon, then press Cursor right (▶) key.



- 3 Press Cursor up/down (▲/▼) keys on the remote to select "Digital Output", then press the Cursor right (▶) key to access the sub features



- 4 Press Cursor up/down (▲/▼) keys on the remote to select specific output mode, then press the ENTER key.

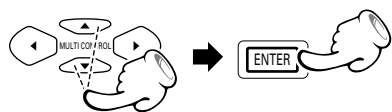

- 5 Press Cursor left (◀) key on the remote to return to previous menu.



- 6 Press the MENU key to return to previous display.

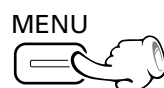

DVD Select LPCM Output

48kHz : Even in case of 96 kHz digital signal, DVD will deliver 48 kHz signal out.

96kHz : In case of 96 kHz digital signal, DVD will deliver 96 kHz signal out. In this case your receiver should control 96 kHz signal.

- 1 During stop mode, press MENU key on the remote.

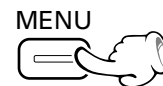

- 2 Press Cursor up/down (▲/▼) keys on the remote to select the "Audio" icon, then press Cursor right (▶) key.



- 3 Press Cursor up/down (▲/▼) keys on the remote to select "LPCM Output", then press the Cursor right (▶) key to access the sub features



- 4 Press Cursor up/down (▲/▼) keys on the remote to select specific output mode, then press the ENTER key.

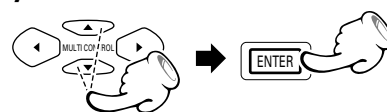

- 5 Press Cursor left (◀) key on the remote to return to previous menu.



- 6 Press the MENU key to return to previous display.



Please refer to page 16 to 18 for setup.

DVD VCD Select TV Screen

- ➊ During stop mode, press MENU key on the remote.



- ➋ Press Cursor up/down (▲/▼) keys on the remote to select the "Video" icon, then press Cursor right (▶) key.



- ➌ Press Cursor up/down (▲/▼) keys on the remote to select "TV Screen", then press the Cursor right (▶) key to access the sub features.



- ➍ Press Cursor up/down (▲/▼) keys on the remote to select TV Screen type, then press the ENTER key.

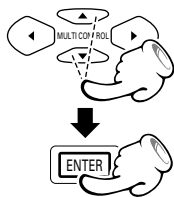

- ➎ Press Cursor left (◀) key on the remote to return to previous menu.



- ➏ Press the MENU key to return to previous display.



DVD VCD Select progressive Mode (for U.S.A., Canada and U.S. Military)

- ➊ During stop mode, press MENU key on the remote.

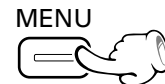

- ➋ Press Cursor up/down (▲/▼) keys on the remote to select the "Video" icon, then press Cursor right (▶) key.



- ➌ Press Cursor up/down (▲/▼) keys on the remote to select "Progressive Mode", then press the Cursor right (▶) key to access the sub features.



- ➍ Press Cursor up/down (▲/▼) keys on the remote to select specific mode, then press the ENTER key.

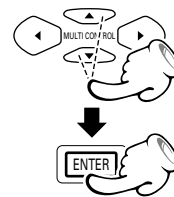

- ➎ Press Cursor left (◀) key on the remote to return to previous menu.



- ➏ Press the MENU key to return to previous display.



Please refer to page 16 to 18 for setup.

DVD VCD Select Video output (for Europe)

- 1 During stop mode, press MENU key on the remote.



- 2 Press Cursor up/down (▲/▼) keys on the remote to select the "Video" icon, then press Cursor right (▶) key.



- 3 Press Cursor up/down (▲/▼) keys on the remote to select "Video output", then press the Cursor right (▶) key to access the sub features.



- 4 Press Cursor up/down (▲/▼) keys on the remote to select specific mode, then press the ENTER key.

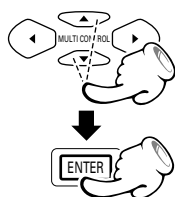

- 5 Press Cursor left (◀) key on the remote to return to previous menu.



- 6 Press the MENU key to return to previous display.



DVD VCD Select Color Scheme

- 1 During stop mode, press MENU key on the remote.



- 2 Press Cursor up/down (▲/▼) keys on the remote to select the "Video" icon, then press Cursor right (▶) key.



- 3 Press Cursor up/down (▲/▼) keys on the remote to select "Color Scheme", then press the Cursor right (▶) key to access the sub features.



- 4 Press Cursor up/down (▲/▼) keys on the remote to select desired Color Scheme, then press the ENTER key.

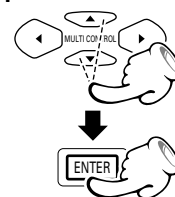

- 5 Press Cursor left (◀) key on the remote to return to previous menu.



- 6 Press the MENU key to return to previous display.



Please refer to pages 16 to 18 for setup.

DVD VCD Set the Custom Color

The custom color can be changed only when "Customed" has been selected in "Color Scheme".

- 1 During stop mode, press MENU key on the remote.

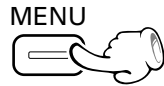

- 2 Press Cursor up/down (▲/▼) keys on the remote to select the "Video" icon, then press Cursor right (▶) key.

"Video" icon



- 3 Press Cursor up/down (▲/▼) keys on the remote to select "Custom Color", then press the ENTER key to access the sub features

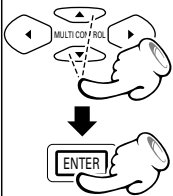

- 4 Press Cursor up/down (▲/▼) keys on the remote to select "Brightness" (brightness).

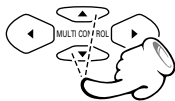

- 5 Press Cursor left/right (◀/▶) keys on the remote to control brightness.

- 6 Press Cursor up/down (▲/▼) keys, select "Contrast", "Saturation", or "Sharpness", and adjust each item in the same way as in step 5.

- 7 Press the ENTER key or RETURN key on the remote.

- 8 Press Cursor left (◀) key on the remote to return to previous menu.

- 9 Press the MENU key to return to previous display.

DVD VCD Select Picture slide scale

- 1 During stop mode, press MENU key on the remote.

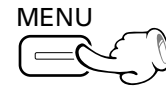

- 2 Press Cursor up/down (▲/▼) keys on the remote to select the "System" icon, then press the Cursor right (▶) key.

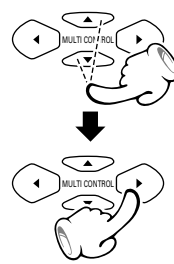

"System" icon

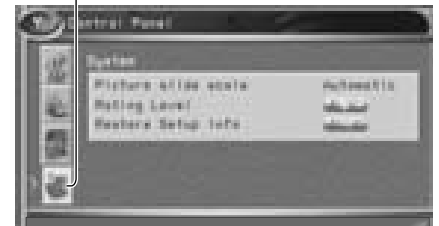

- 3 Press Cursor up/down (▲/▼) keys on the remote to select "Picture slide scale", then press the Cursor right (▶) key to access the sub features.

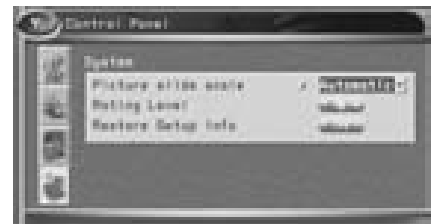
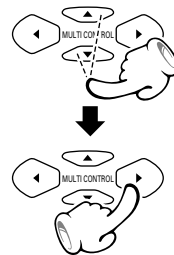

- 4 Press Cursor up/down (▲/▼) keys on the remote to select "Fixed" or "Automatic", then press the ENTER key.

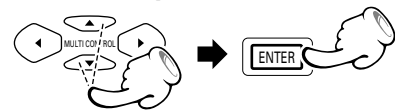

- 5 Press Cursor left (◀) key on the remote to return to previous menu.



- 6 Press the MENU key to return to previous display.



Please refer to pages 16 to 18 for setup.

DVD Select Rating level

This part of DVD rating lets you determine how your player will react discs that contain movies that are rated (in the U.S.A. the Motion Pictures Association of America rates movies as G, PG, PG-13, etc.).

- 1 During stop mode, press MENU key on the remote.



- 2 Press Cursor up/down (▲/▼) keys on the remote to select the "System" icon, then press the Cursor right (▶) key.

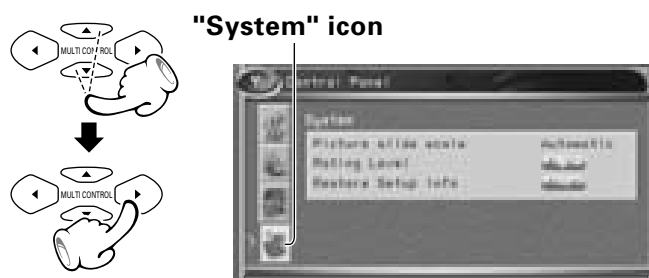

- 3 Press Cursor up/down (▲/▼) keys on the remote to select "Rating Level", then press the ENTER key to access the sub features.



- 4 Input 4 digit password by press numeric keys, then press the ENTER key.

The password set at the time of shipping from the factory is "0000".

To change the password, follow the procedure shown on page 25.

Press the RETURN key on the remote control to quit setup.

- 5 Select "Rating Level", then press the ENTER key.

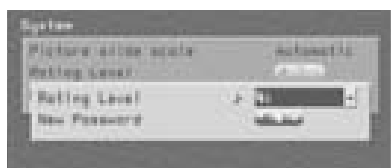

- 6 Press Cursor up/down (▲/▼) keys on the remote to select specific level, then press the ENTER key.

- 7 Press RETURN key on the remote to return to previous menu.

- 8 Press the MENU key to return to previous display.

DVD Change Password

- 1 During stop mode, press MENU key on the remote.



- 2 Press Cursor up/down (▲/▼) keys on the remote to select the "System" icon, then press the Cursor right (▶) key.

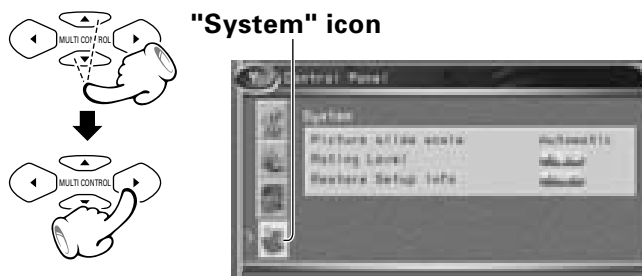

- 3 Press Cursor up/down (▲/▼) keys on the remote to select "Rating Level", then press the ENTER key to access the sub features.



- 4 Input 4 digit password by press numeric keys, then press the ENTER key.

The password set at the time of shipping from the factory is "0000".

- 5 Select "New Password", then press the ENTER key.



- 6 Press the numeric keys to enter new password (4 digit), then press the Cursor down (▼) key.

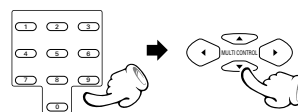

- 7 Enter new password again, then press the ENTER key on the remote.

- 8 Press RETURN key on the remote to return to previous menu.

- 9 Press the MENU key to return to previous display.

Please refer to pages 16 to 18 for setup.

CD DVD VCD Put back to the Default Setting

DVD DVD menu language list

- ① During stop mode, press MENU key on the remote.

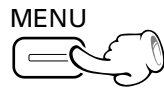

- ② Press Cursor up/down (▲/▼) keys on the remote to select the "System" icon, then press the Cursor right (▶) key.

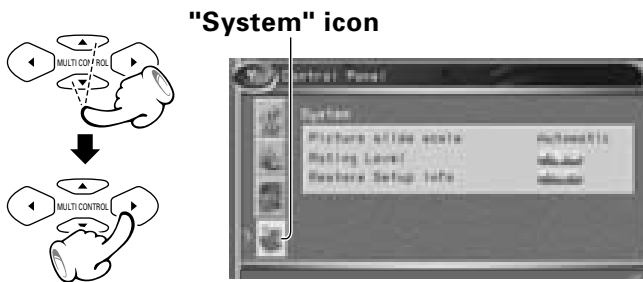

- ③ Press Cursor up/down (▲/▼) keys on the remote to select "Restore Setup Info", then press the ENTER key.



- This resets all settings, except for PARENTAL and PASSWORD, to the factory defaults.

- ④ Press Cursor left (◀) key on the remote to return to previous menu.



- ⑤ Press the MENU key to return to previous display.





OSD display	Language
ENG	English
CHI	Chinese
DNK	Danish
GER	German
SPA	Spanish
FRE	French
HIN	Hindi
HUN	Hungarian
IDN	Indonesian
ITA	Italian
JAP	Japan
KOR	Korea
MNG	Mongolian
MYS	Malay
POL	Polish
POR	Portuguese
ROM	Romanian
RUS	Russian
SVK	Slovak
SWE	Swedish
THA	Thailand
TUR	Turkish
VNM	Vietnamese
NOR	Norwegian
FIN	Finnish

Basic play

Preparation

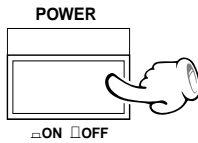
MAIN UNIT



- Set the **POWER ON/OFF** switch to the ON () position.
- After the power is switched ON, there is a delay of about 3 seconds before the display is lit.

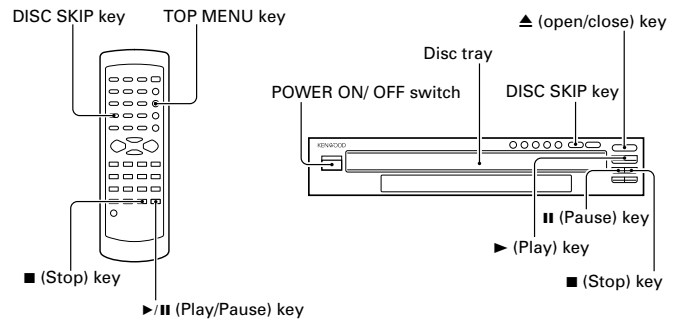

1 Load a disc.

1 Open the tray.

MAIN UNIT

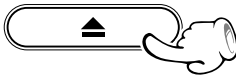

2 Place a disc.

3 To set a disc to a different disc tray, press the DISC SKIP key to change the position of the disc tray.

MAIN UNIT

REMOTE

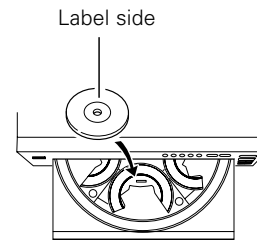

2 Start playback.

MAIN UNIT

REMOTE

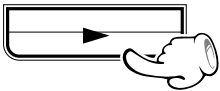

- When the **▶/||** key is pressed while a tray is open, the tray closes automatically, and then playback begins.



Do not push the disc tray directly to close it. Always press the **▲ key on the main unit or the **▶/||** key on the remote control to close the disc tray.**

When a Disc Menu appears on the screen

In case of interactive DVDs, a Disc Menu appears on the screen. Then press **ENTER** to select specific menu you want to play by using Cursor keys.

TITLE No. (DVD)

CHAPTER No. (DVD)

Time display

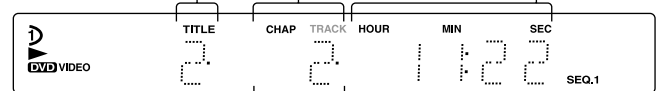

TRACK No. (CD/VCD)

- To pause playback press the **||** key on the main unit or press the **▶/||** key on the remote.

When a menu screen is recorded on the disc, the menu screen will be displayed when the TOP MENU key or MENU key is pressed. At the menu screen, the menu can be selected by pressing the Cursor keys and ENTER key.



To stop playback

MAIN UNIT

REMOTE

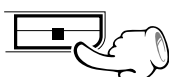

RESUME playback (only for DVD)

When the **■** (Stop) key has been pressed once during playback to stop the playback, and then playback is started again, play will start from the point where the playback had been stopped. This is called the RESUME function. When the **■** (Stop) key is pressed again during stop, the RESUME function is cancelled.

Disc playback features



- You won't hear the sound (audio) on the DVD and VCD when you're using the Skip, Search, Step or Slow motion features.
- Playback features are not available during the opening credits of a movie.

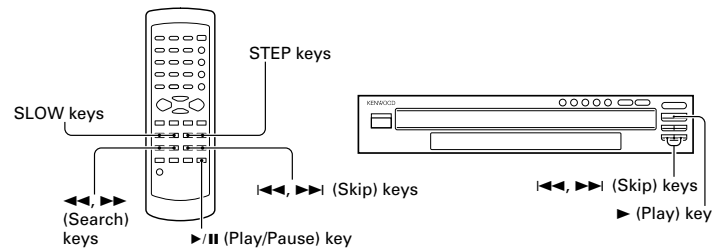

CD DVD VCD **Skipping chapters or tracks**

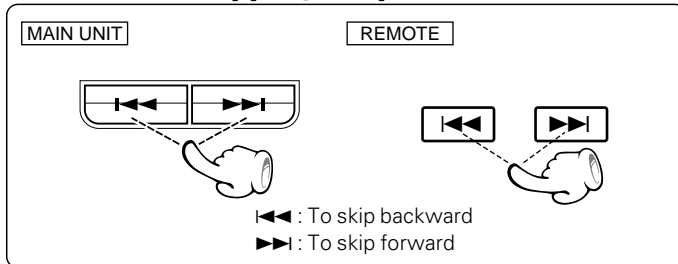

- The chapter (or track) in the direction of the key pressed is skipped, and the selected chapter (or track) will be played from the beginning.
- When the ◀◀ key is pressed once during playback, the chapter (or track) being played will be played from the beginning.

CD DVD VCD **Searching**

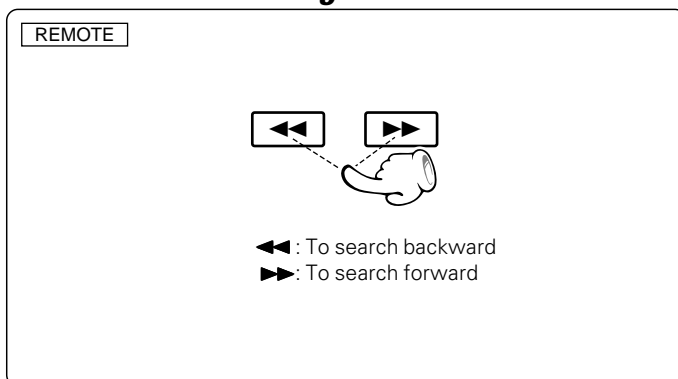

- During playback, press the ◀◀ or ▶▶ key.
- Each press switches the searching speed.
 - ① Fast Play / Fast Back Play
 - ② Scan Forward 1 / Scan Backward 1
 - ③ Scan Forward 2 / Scan Backward 2
 - ④ Scan Forward 3 / Scan Backward 3 (Only for DVD)
 - ⑤ Scan Forward 4 / Scan Backward 4 (Only for DVD)
 - ⑥ Play
- Audio is not output during forward or reverse search. (VCD/ DVD)
- Press the ▶|| key at any time to resume normal playback.

DVD VCD **STEP (freeze frame and frame advance)**

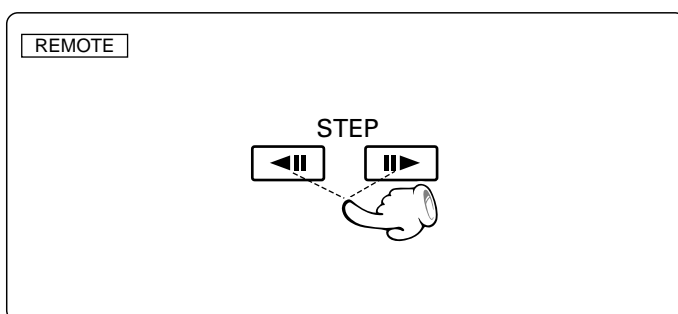

- During playback, press the **STEP** keys.
- Each time you press the keys, the picture advances one frame.
- At the time of VCD playback, backward STEP is not possible.
- Press the ▶|| key to resume normal playback.

DVD VCD **Slow motion playback**

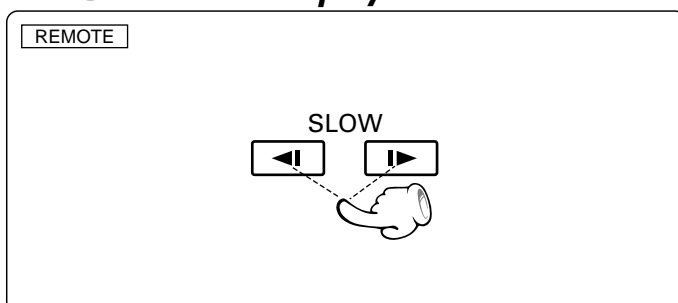

- During playback, press the **SLOW** keys.
- Each press switches the motion speed.
 - ① Slow 1/16 (Back Slow 1/16) (Only for DVD)
 - ② Slow 1/8 (Back Slow 1/8)
 - ③ Slow 1/4 (Back Slow 1/4)
 - ④ Slow 1/2 (Back Slow 1/2)
 - ⑤ Play (Back Play)
- Press the ▶|| key to resume normal playback.
- At the time of VCD playback, Back Slow is not possible.

CD DVD VCD Playback from desired track or title

Because DVD VIDEO discs use digital technology, a title can be divided into individual chapters (similar to tracks on a CD).

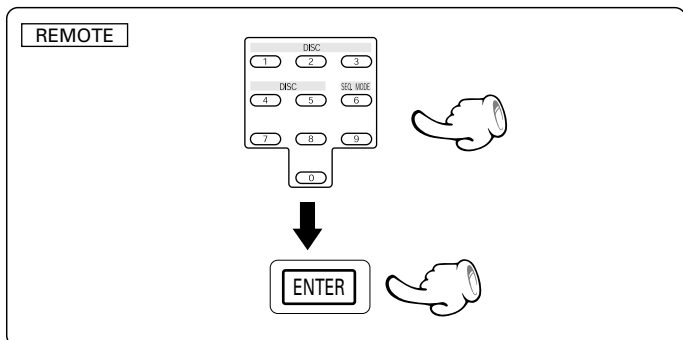

- Select the desired track No. (CD, VCD) or title No. (DVD)

1 Press the numeric keys as shown below

(Example) To select track No. 23 : **2 3**

2 Press the **ENTER** key.



- P.B.C. on mode of VCD, the Selecting a Track function may not work. → **39**

DVD CD VCD Playing discs by changing them

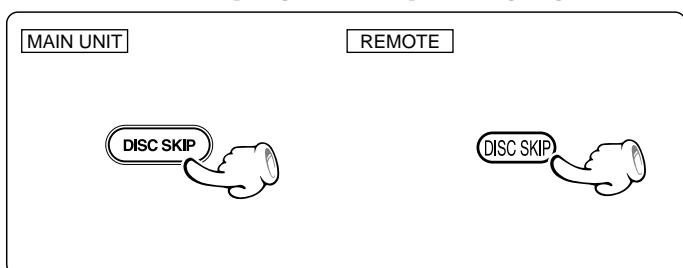

- Press **DISC SKIP** key to skip a disc.
- When the **DISC SKIP** key is pressed while the tray open, the tray simply rotates.

DVD CD VCD Playing from the selected disc

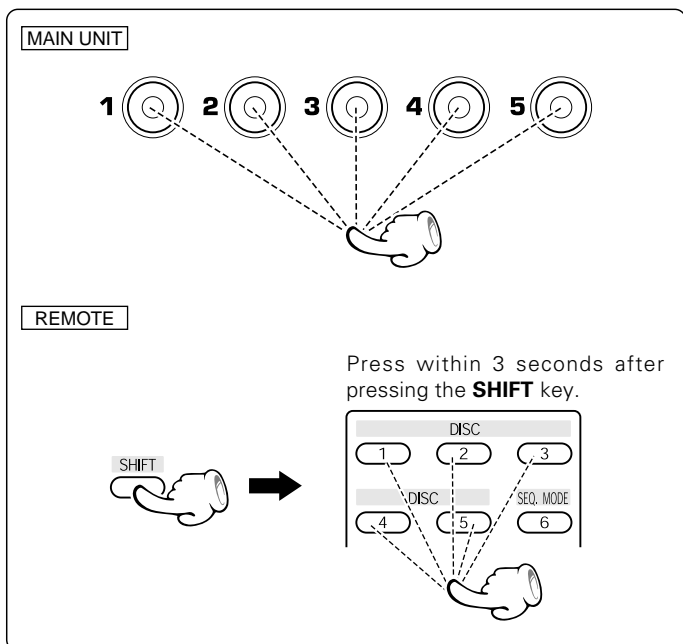

- Press one of the **Disc 1 to Disc 5** key to select a disc.
- The disc number indicator above one of the **Disc 1 to Disc 5** key on the main unit lights up and playback starts.
- At the time of operating on the remote, press the **1 to 5 (DISC)** key within 3 seconds after pressing **SHIFT** key.



If a disc is added or removed during playback or stop, the disc indicator may show incorrect information on discs. In this case, press the **Disc 1 to Disc 5** keys so that the unit loads the correct positioning of each disc and judges its presence.

DVD CD VCD Switching sequential play mode

The player is capable of sequential playback using the 5 disc carousel disc changer. If a DVD and/or VCD is mixed in the discs to be played sequentially, the sequential playback may stall in the middle while the menu remains displayed. In such a case, switch the sequential play mode of the player.

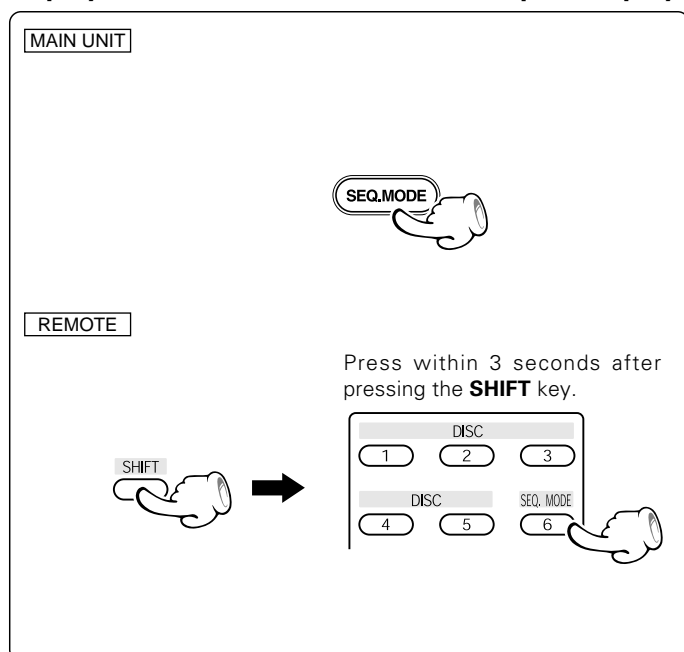

- Press **SEQUENCE MODE** key to select play mode.
- At the time of operating on the remote, press the **6 (SEQ.MODE)** key within 3 seconds after pressing **SHIFT** key.
- Each press switches the sequential play mode.
 - ① **Sequential play mode 1 (SEQ.1)**
 - ② **Sequential play mode 2 (SEQ.2)**

Sequential play mode 1("SEQ.1" lit)

All discs can be played including DVD discs.

- When there is a P.B.C.-compatible VCD or a DVD on the tray, sequential playback may sometimes be interrupted and the menu displayed. In this case, perform menu playback.

Sequential play mode 2("SEQ.2" lit)

Playback of DVD discs is skipped in order not to interrupt sequential playback.

- With a P.B.C.-compatible VCD, playback is performed by switching P.B.C. automatically to off.
- When there is a VCD on the tray, SEQ. 2 playback may sometime be interrupted.

DVD CD VCD On screen display

The elapsed time or the remaining time for the chapter or the track can be displayed on the monitor (TV) screen.

Press the **ON SCREEN** key on the remote.

Each press the key switches the display.

At the time of DVD playback.

ON SCREEN



- ① **Title Time**
Elapsed time of the title being played.
- ② **Title Remain Time**
Remaining time of the title being played.
- ③ **Chapter Time**
Elapsed time of the chapter being played.
- ④ **Chapter Remain Time**
Remaining time of the chapter being played.
- ⑤ **Second banner display**
Audio information, Subtitle display etc.
- ⑥ **Goes off**

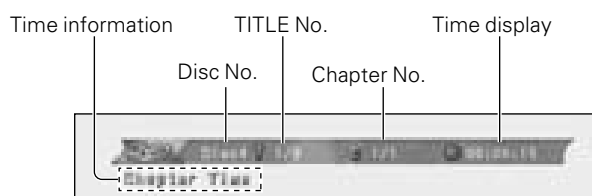

At the time of CD/VCD playback.

- ① **Track Time**
Elapsed time of the track being played.
- ② **Track Remain Time**
Remaining time of the track being played.
- ③ **Disc Time***
Elapsed time of the disc being played.
- ④ **Disc Remain Time***
Remaining time of the disc being played.
- ⑤ **Goes off**

*** Items marked with an asterisk (*) may not be displayed for a VCD in P.B.C. ON mode.**

- The time information is switched off when no operation is performed for about 10 seconds.

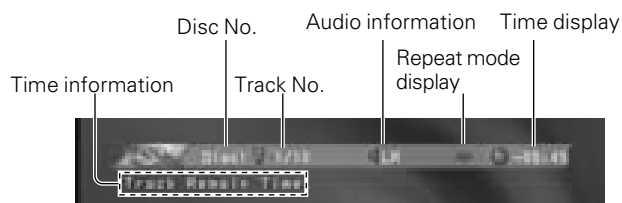

Second banner display

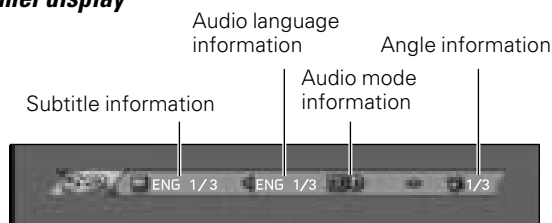

DVD Select Audio Language

If the disc was created with different language tracks, you can use the **AUDIO KEY** on the remote to temporarily change the DVD player's Audio setting.

During playback, press the **AUDIO** key on the remote.



Audio information

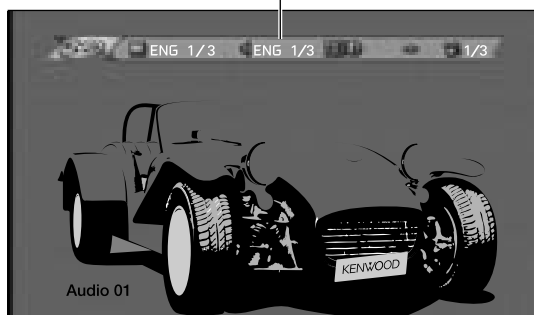

The language is switched each time the **AUDIO** key is pressed.

- The display is switched off when no operation is performed for about 3 seconds.



1. The language feature only works if the disc was created with multiple audio tracks.
2. When you chose an audio language by the **AUDIO** key, you only override the audio language setting in the DVD Player's main menu (in the Language Preferences menu within Setup menu) temporarily.

VCD Select the Audio channel

You can choose to play back only the right or the left channel of audio recorded on the disc, or you can select stereo playback.

During VCD playback, press **AUDIO** key on the remote.



Each press the key switches the mode.

- ① Audio Left
- ② Audio Right
- ③ Stereo

DVD Select Subtitle Language

You can change the Subtitle language while you're watching a disc (but only if the disc was created with subtitles).

During playback, press the **SUBTITLE** key on the remote.



Subtitle information

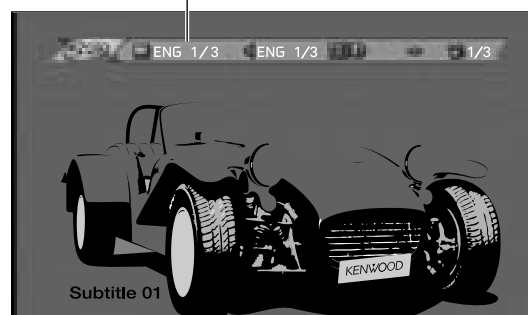

The language is switched each time the **SUBTITLE** key is pressed.

- The display is switched off when no operation is performed for about 3 seconds.



1. The subtitle feature only works if the disc was created with multiple subtitle tracks.
2. The subtitle menu of the disc appears in some discs.

DVD Select Subtitle on or off

When the **SUBTITLE ON/OFF** key is pressed, subtitles will be displayed. Switching between display of subtitles and no display of subtitles is done each time the key is pressed.

Press **SUBTITLE ON/OFF** key on the remote.



DVD Select Camera angle

Some disc contains multiple angles particular scene or sequence. If the disc only has one angle, this feature won't work.

- 1 During playback, press the ANGLE key on the remote.

ANGLE



Angle information

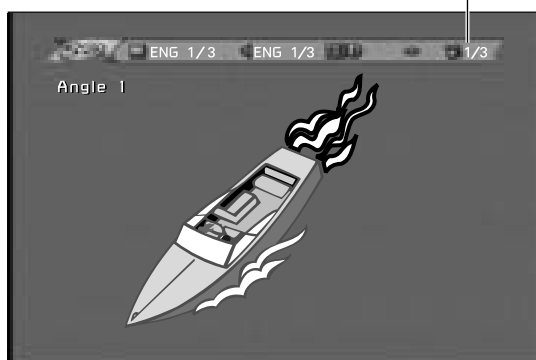

- 2 Select the Camera angle with press the ANGLE key.

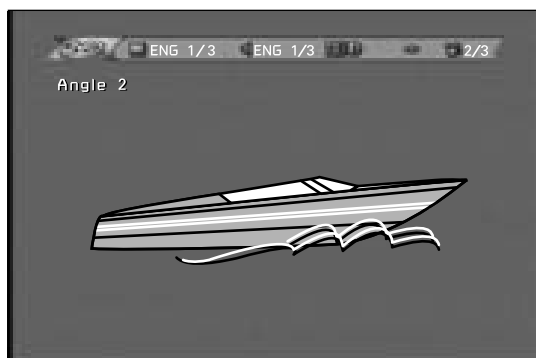

The display can be extinguished by pressing the ON SCREEN key.

CD VCD Random play

The tracks of the current disc are played in random order.

- 1 During STOP mode, press the RANDOM key on the remote.



The Random Play display appears



Lit

RANDOM

Display

Each time you press RANDOM key on the remote, random play would be on and off.

- 2 Press the play pause (▶/II) key to start random playback.

- The display is switched off when no operation is performed for about 3 seconds.

"MP3/JPEG Random play" → 43

To cancel random play

- 1 Press the stop (■) key to stop playback.
- 2 Press the RANDOM key to cancel random playback.



- In **RANDOM** mode, playback of the disc will be continued.
- When playing a DVD, the Random function may not work.
- P.B.C. on mode of VCD, the Random play function may not work. → 39

DVD CD VCD Repeat play

Desired title, chapter, track or disc can be played back repeatedly.

At the time of DVD playback.

- "Repeat Chapter" : Repeat the chapter that is playing.
- "Repeat Title" : Repeat the title that is playing.

At the time of CD/VCD playback.

- "Repeat One" : Repeat the track that is playing.
- "Repeat All" : Repeat the disc that is playing.

During playback, press the REPEAT key on the remote.



Each press of the key switches the REPEAT mode

At the time of DVD playback.

- ① "Repeat Chapter" : Display lit "REPEAT 1"
- ② "Repeat Title" : Display lit "REPEAT"
- ③ "Repeat Off"

At the time of CD/VCD playback.

- ① "Repeat One" : Display lit "REPEAT 1"
- ② "Repeat Disc" : Display lit "REPEAT DISC"
- ③ "Repeat Off"



At the time of REPEAT mode "REPEAT" is light.

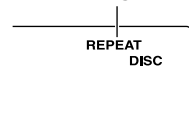

Display

- To cancel repeat playback, press the REPEAT key and select "Repeat Off".
- The display is switched off when no operation is performed for about 7 seconds.

DVD CD VCD A-B Repeat play

The A-B repeat function lets you mark a segment to repeat between the beginning "A" and the end "B" of the segment you want to replay.

- ① Press the A-B key on the remote when you want to choose a scene (sound) as the beginning point.

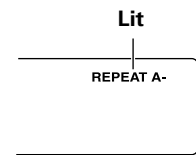
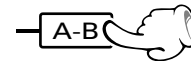

Display

- ② Press the A-B key again to choose a scene (sound) as the end point.

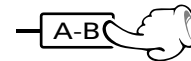

The Repeat B (Repeat A-B) display appears

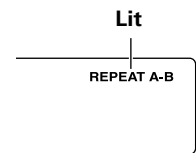

Display

- To cancel A-B Repeat playback, press the A-B key.
- The display is switched off when no operation is performed for about 7 seconds.

"MP3/JPEG Repeat play" → 42



P.B.C. on mode of VCD, the Repeat play function may not work. → 39

DVD VCD *Using Bookmarks*

The bookmark feature lets you mark a point on the disc that you can go to quickly.

Create the bookmark

- 1 During playback, press the **RANDOM** key on the remote.



- 2 Press **Cursor left/right** (\leftarrow/\rightarrow) keys on the remote to select desired bookmark number.

- 3 When you reach the scene you want to mark, press **ENTER** key.



- Up to 6 bookmarks can be applied in the same way for one disc.

Recalling a bookmarked scene

- 1 During playback, press the **RANDOM** key on the remote.



- 2 Press the **Cursor left/right** (\leftarrow/\rightarrow) keys on the remote to recalling a bookmark number.



- 3 Press the **play/pause** (\triangleright/\parallel) key.



Delete a bookmark

- 1 During playback, press the **RANDOM** key on the remote.



- 2 Press the **Cursor left/right** (\leftarrow/\rightarrow) keys on the remote to select a bookmark number to be deleted.

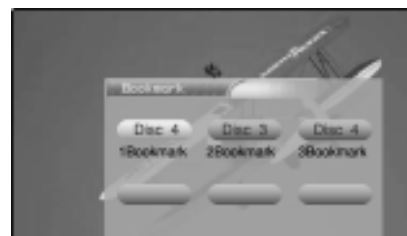

- 3 Press the **CLEAR** key on the remote.

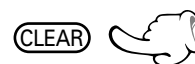

- Depending on the disc, the Bookmark function may not work.
- P.B.C. on mode of VCD, the Bookmark function does not work. → 39

To delete all bookmarks

Open the disc tray or turn power off.

You can listen to the desired tracks of discs in any desired order.

Program Edit

- 1 During stop mode, press the P.MODE key on the remote.

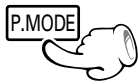

- Note** As the information for all set discs is read, some time may be required until the program screen is displayed.

- 2 After Program edit display appears, press Cursor right (▶) key.

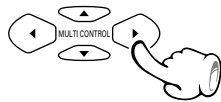

- 3 Press Cursor up/down (▲/▼) keys to select "Add" icon, then press ENTER key.

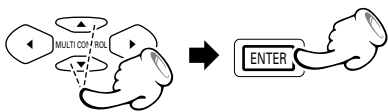

For correction after programming, select a different icon instead of the "Add" icon.

"Add" : Adds a track to the program.

"Insert" : Adds a track between programs. In this case, insertion is made above (before) the selected program.

"Modify": Modifies the program.

"Delete" : Deletes the selected program.

"Clear" : Deletes all programs.

- 4 Press Cursor up/down (▲/▼) keys to select Disc No., then press ENTER key.

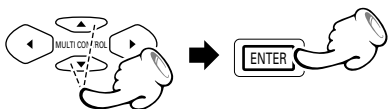

Program edit display appears.

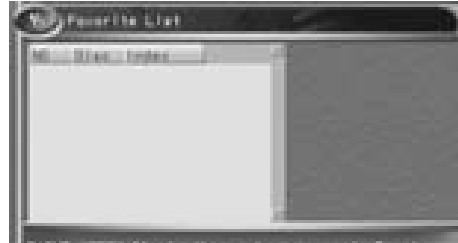

"Add" icon

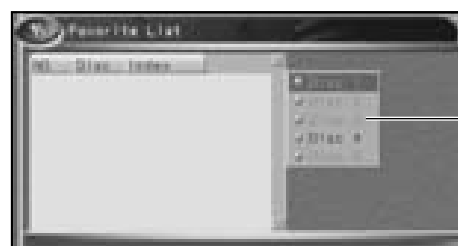
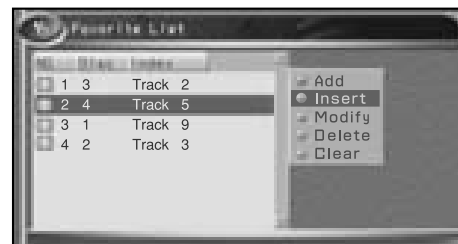

Disc No.

Continued on next page...

- 5 Press Cursor up/down (▲/▼) keys to select track, then press ENTER key.

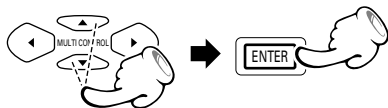

- 6 You can select maximum 19 values by repeating step 5 - 5.

- 7 Press the play/pause (▶/||) key on the remote or play (▶) key on the main unit to start program play.

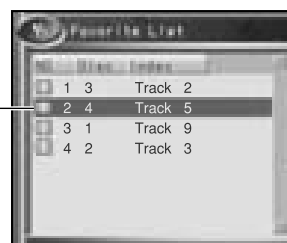

Program playback will start from the selected program.
Playback will stop when the end of the program is reached.

- Program playback will start from the selected program.
- Playback will stop when the end of the program is reached.

To stop program play

Press the stop (■) key.



- When the STOP key is pressed, the player will stop with the program contents stored.
- When the play/pause (▶/||) key or play (▶) key is pressed, normal playback will start.
- To restart program playback, press the P.MODE key to display the program screen and then press the play/pause (▶/||) key or play (▶) key.

Delete Program

Select "Delete" or "Clear" in step 6 of "Program Edit".

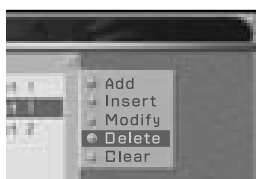

Release Program play

In following case, Program play would be released.

1. When you open and close tray.
2. When you turn power off and on.



VCD Hierarchical structure of VCD menus

When an item is selected on the menu screen during playback of a P.B.C.-compatible VCD, another menu with more details items may be displayed. When a number of menus are connected in multiple layers in this way, it is said that the menus have a hierarchical structure. In this structure, the desired scene can be reached by repeating item selections on the menu screens.

Example for a hierarchical structure

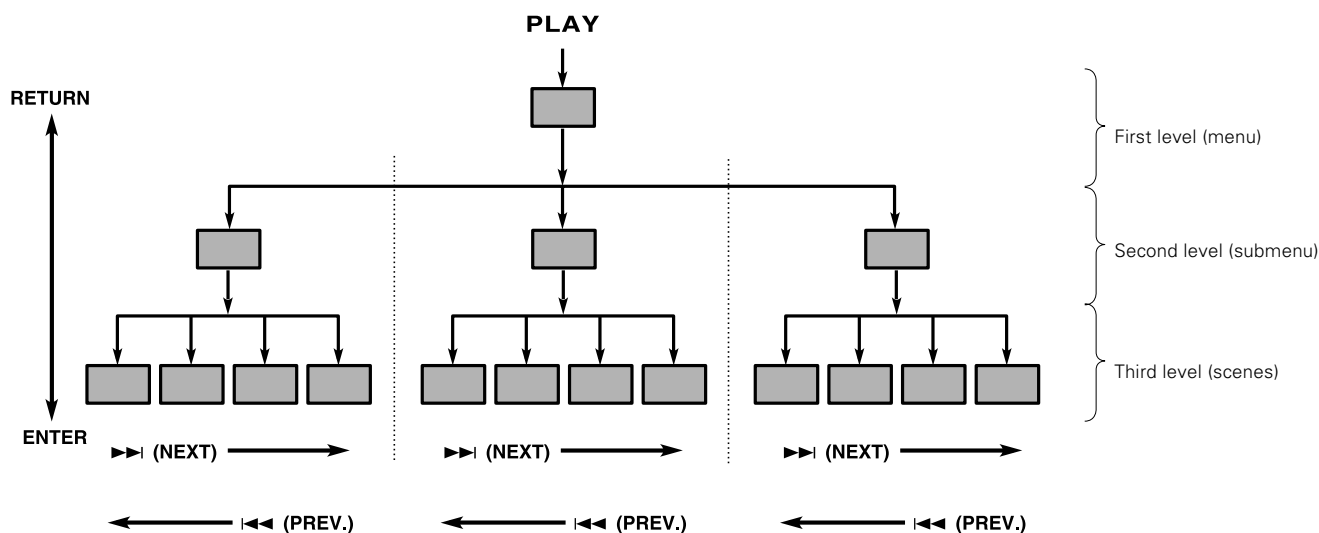

Advancing

When an item is selected on the menu screen with the ENTER (Select) key or the numeric keys, advance is made to the next lower menu level. When the advance destination is the "scene" to be played, the contents will be played.

- When several menus (scenes) can be selected in each level, screen switching is possible with the keys ►► (NEXT) and ◀◀ (PREV.).

Returning

Each time the RETURN key is pressed, return is made to the next higher menu.

Examples of operation keys and indications used during VCD playback

Soft jacket indication	►	◌●	◀◀	►►	► (Select)
KENWOOD operation key	►/	RETURN	◀◀	►►	ENTER

- Depending on the software, the jacket indication may differ from the above.

VCD Playback without using the menu playback function
(In case of a P.B.C.-compatible VCD) (To P.B.C. On or Off)

During VCD playback and stop mode, press the –ON/OFF key on the remote control unit.



- For the track numbers, refer to the disc jacket or other material.
- P.B.C. off mode : Without using menu playback function.

P.B.C. off mode

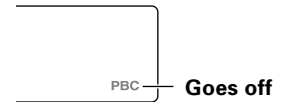

To return to menu playback

Press the –ON/OFF key again.

P.B.C. on mode

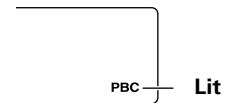

Guidance of MP3/JPEG

MP3/JPEG media that can be played back with this equipment

Usable media : CD-ROM, CD-R, CD-RW

Usable formats : ISO9660 level 1 (excluding expanded formats)

Files that can be played back : MP3 files and JPEG files

Creating media for playing back on this equipment

Compressing MP3

Please set up the transfer bit rate setting for the compression software when compressing MP3 files as follow.

MP3 Files : 128kbps recommended (32kbps-320kbps)

- **This unit is compatible with 32 kHz, 44.1 kHz(recommended) and 48 kHz sampling frequencies.**
- **This unit is compatible with ID3-TAG Ver. 1.**
- **DIGITAL output of MP3 data is done not as MP3 data, but as PCM data.**

Naming folders and files

Single-byte characters between A and Z, single-byte numerals between 0 and 9, and the single-byte underscore(_) can be displayed. Ensure that the "mp3" (MP3 files) or "jpg" (JPEG files) extension log is attached to all file names

- **Never add the "mp3" extension log to any files other than MP3 files. If the "mp3" extension log is added to any files other than MP3 files, the equipment will assume that they can be played back, and this will produce loud noises in the speakers, resulting in damage of adverse effects.**
- **Never add the "jpg" extension log to any files other than JPEG files. If the "jpg" extension log is added to any files other than JPEG, the unit will not operate normally.**

Confirming media and files

Check to ascertain that MP3 files can be played back correctly on the personal computer in use prior to saving them onto the media. Check to ensure that the saved file can be played back normally.

- **It is not possible to confirm that files can be played back correctly while they are being saved onto the media.**

When saving files onto media

Ensure that the session is closed or finalized when data has been written on media. There are cases where media on which the session has not be closed or finalized will not be played back correctly with this equipment.

- **There are cases where the folder names and file names will not be displayed correctly depending on the software used to save them.**
- **Do not store files or folders other than MP3 or JPEG on media to be played back with this equipment.**
- **It is recommended that ten or less sessions are stored when recording MP3 files onto a media.**
- **In case of a multisession disc, some time may be required until playback begins.**
- **There are cases where playback is not possible when MP3/JPEG files (CD-ROM) and music CD information (CD-DA) are saved on the same media.**

Example for a hierarchical structure

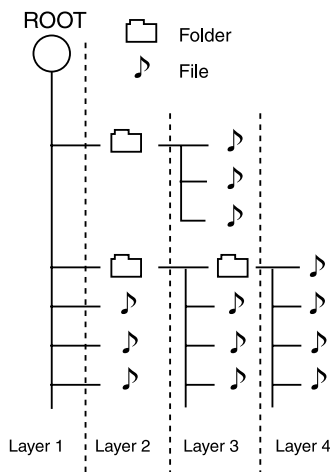

Example for the playback sequence

Playback is made in the order of ① to ⑪ in the following example.

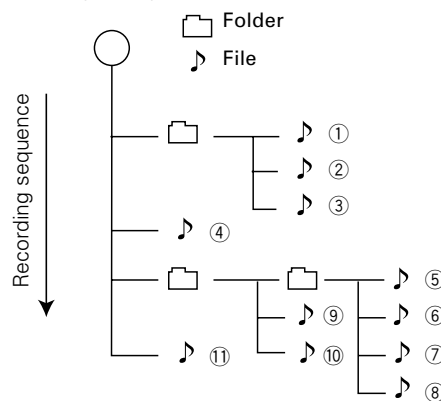

Folder names and file names are displayed up to 8 characters. When folder names and file names are recorded with more than 8 characters, the names will be displayed in abbreviated form.

Playing back MP3/JPEG files

- It is not possible to play back folders and files that exceed the maximum limitations of the media.
- A certain amount of time is required for the player to confirm the media on which MP3/JPEG files have been recorded before playback will commence.

Playback

- 1 Press Cursor up/down (▲/▼) keys on the remote, then press the ENTER key.

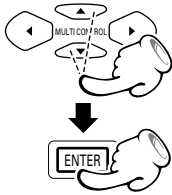

The selected folder will be opened. Repeat in the same way until the file to be played is displayed.

- 2 Select desired file, then press the ENTER key or play/pause (▶/⏸) key.

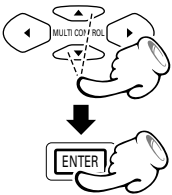

In case of playback of JPEG files

- When the Play/pause (▶/⏸) key is pressed, switching to the next file will take place approx. every 5 seconds. When the STOP key is pressed, the respective file remains displayed. (Stop condition)
- When the ENTER key is pressed, the respective file remains displayed. (Stop condition)
- The ZOOM function can be used at the time of stop condition. (→ 43)
- For a disc with mixed MP3 and JPEG files, simultaneous playback of MP3 and JPEG files is possible by selecting a JPEG file after MP3 playback. In this case, the MP3 sound may be interrupted while the JPEG file is being read when the JPEG file is large.

Skipping files

During playback, press the ◀◀ or ▶▶ key.



◀◀: To skip backward
▶▶: To skip forward



Skipping to outside the folder being played back is not possible.

- When MP3/JPEG files are set, the SMART NAVI screen is displayed.

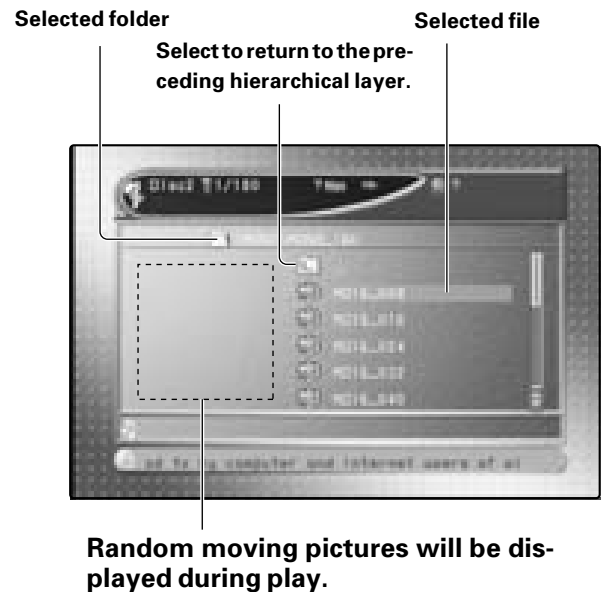
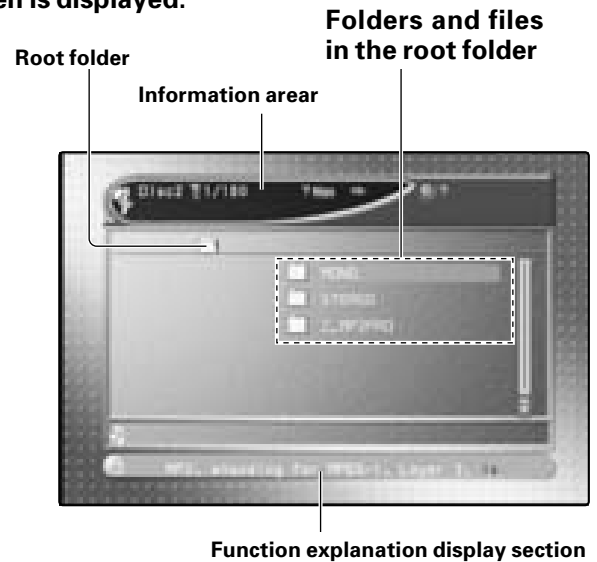

To stop playback

Press the ■ (STOP) key.

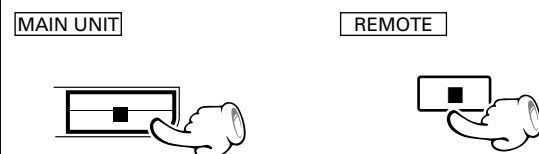

Fast forwarding and fast reversing is not possible with MP3/JPEG files.

Rotating a picture (JPEG files only)

It is possible to rotating a picture.

When a JPEG picture is larger than the screen and extends beyond the screen, this function is not effective. In such a case, perform zoom-out for the picture before you rotate it. ("ZOOM function" → 43)

When JPEG file is being displayed (stopped playback), press the Cursor (◀/▶/▲/▼) keys on the remote.

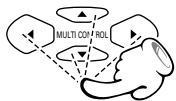

Switching as shown below is done when the cursor keys are pressed.

- ▶ key : 90° rotation in clockwise direction
- ◀ key : 90° rotation in counterclockwise direction
- ▲ key : vertical mirror image
- ▼ key : Horizontal mirror image

Display examples

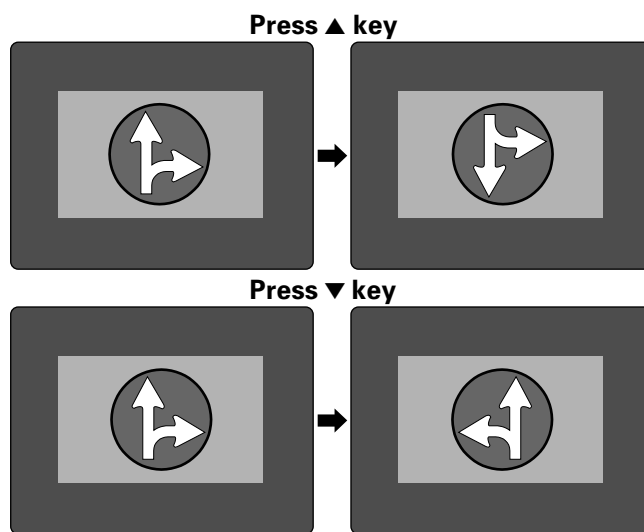
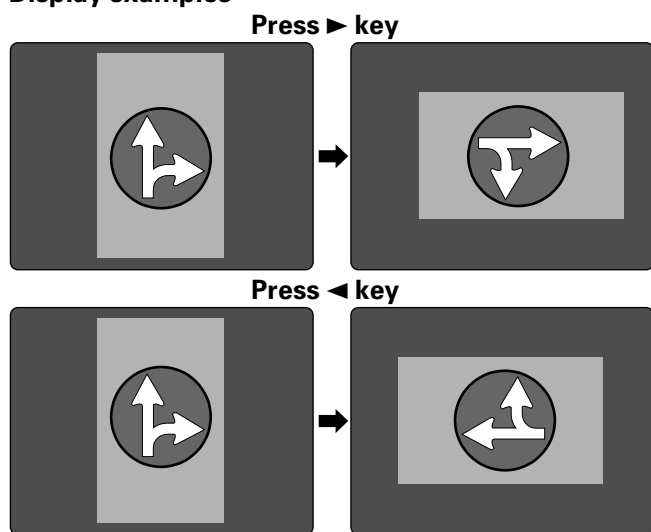

MP3/JPEG Repeat play

Desired folders or discs can be played back repeatedly.

- "Repeat One" : Repeat the file that is playing.
- "Repeat Dir" : Repeat the folder (directory) that is playing.
- "Repeat Disc" : Repeat the disc that is playing.

During playback, press the REPEAT key on the remote.



At the time of REPEAT mode
"REPEAT" is light.

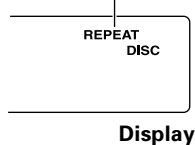

Display

Each press the key switches the REPEAT mode

- ① "Repeat One" : Display lit "REPEAT 1"
- ② "Repeat Dir" : Display lit "REPEAT"
- ③ "Repeat Disc" : Display lit "REPEAT DISC"
- ④ "Repeat Off"

Repeat display

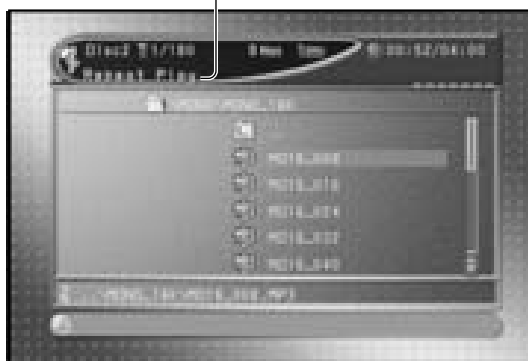

- To cancel repeat playback, press the REPEAT key and select "Repeat Off".

MP3/JPEG Random play

The files of a folder are played in random order.

- "RANDOM ON" : The files of a folder being played will be selected in random order for playback.

- 1 During STOP mode, press the RANDOM key on the remote.



Each time you press RANDOM key on the remote, random play would be on and off.

- 2 Press the play pause (▶/||) key to start random playback.



To cancel random play

- 1 Press the stop (■) key to stop playback.



- 2 Press the RANDOM key to cancel random playback.



Entry into Random mode is not possible during Repeat mode. In that case, switch off Repeat mode and then press the RANDOM key.

ZOOM function (only for JPEG files)

When JPEG file is being displayed (stopped playback), the screen display size can be changed in five steps.

Press the STEP keys during stopped playback of JPEG file.

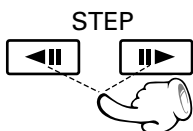

The display size changes each time a key is pressed, The display changes in 5 steps for zooming in and out.

When the zoomed picture is larger than the display screen, the cursor (◀/▶/▲/▼) keys can be used to move the picture so that the parts outside the screen can be displayed.

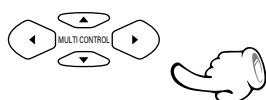

Random display



- In **RANDOM** mode, playback of the disc will be continued.
- In case of Random play for a disc with mixed MP3 and JPEG files, random play will be performed only for MP3 files when the file selected first is an MP3 file and only for JPEG files when the file selected first is a JPEG file.

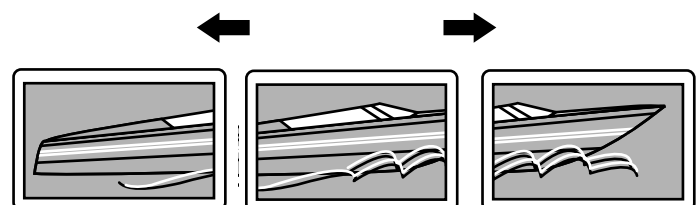
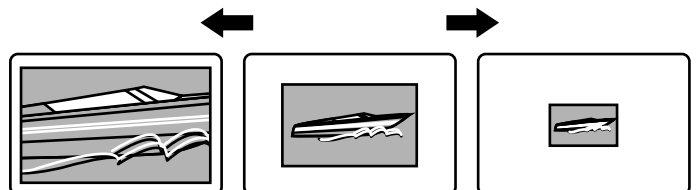

MP3 program playback

You can listen to the desired files of the current MP3 disc in any desired order. It is not possible to program playback of JPEG files.

Program play for MP3 files can be performed with the same operation as for music CDs and VCDs.



Program Edit

- ① Press the P.MODE key on the remote.



As the information for all set discs is read, some time may be required until the program screen is displayed.

- ② Press Cursor right (▶) key.

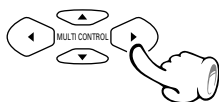

- ③ Press Cursor up/down (▲/▼) keys to select "Add" icon, then press ENTER key.

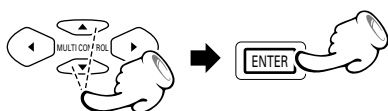

For correction after programming, select a different icon instead of the "Add" icon.

- ④ Press Cursor up/down (▲/▼) keys to select Disc No., then press ENTER key.

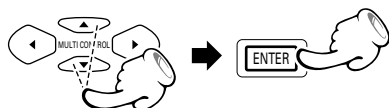

- ⑤ Press Cursor up/down (▲/▼) keys to select track, then press ENTER key.

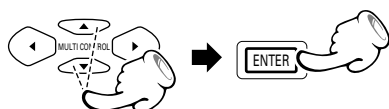

- ⑥ You can select maximum 19 values by repeating step ② - ⑤.

- ⑦ Press the play/pause (▶/||) key on the remote or play (▶) key on the main unit to start program play.

Program edit display appears.



"Add" icon

"Add" : Adds a track to the program.

"Insert" : Adds a track between programs. In this case, insertion is made above (before) the selected program.

"Modify" : Modifies the program.

"Delete" : Deletes the selected program.

"Clear" : Deletes all programs.

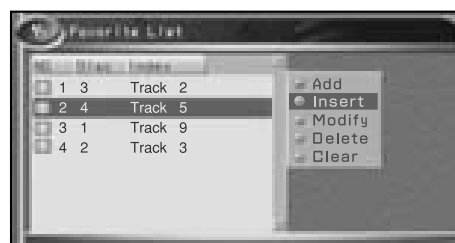

Disc No.

- Program playback will start from the selected program.
- Playback will stop when the end of the program is reached.

To stop program play, press the stop (■) key.

What appears to be a malfunction may not always be serious. If your unit should not perform as expected, consult the table below to see if the problem can be corrected before seeking help from your dealer or service representative.

Operation to reset

The microprocessor may fall into malfunction (impossibility to operate erroneous display, etc.) when the power cord is unplugged while power is ON or due to an external factor.

In this case, switch off the power, wait for several seconds, and then switch the power on again.

Return to the factory defaults by resetting the microprocessor is done as shown as follows.



- ① During stop mode, press the **MENU** key on the remote to enter "Control Panel" menu.
- ② Select the "System" icon, then press the Cursor right (▶) key.
- ③ Select "Restore Setup Info".
- ④ Press the numeric keys as shown below.
Press **[1]**, **[3]**, **[9]**, **[7]**, then press the **ENTER** key.

When resetting is done according to this method, all settings, including the settings for password and parental level, will be reset to the factory defaults.

DVD player unit

Symptom	Cause	Remedy
Playback does not start when the ▶/II key is pressed.	<ul style="list-style-type: none"> ● There is no disc in the player. ● There are no signals recorded on the side of the disc being played. 	<ul style="list-style-type: none"> ● Load a disc and press the ▶/II key. ● Turn the disc over and properly place it on the disc tray.
Playback starts but no image/sound is seen/heard.	<ul style="list-style-type: none"> ● The TV is not turned on. ● The connection cords are not properly connected. 	<ul style="list-style-type: none"> ● Turn on the TV. ● Properly reconnect the connection cords. →
The picture is disrupted when the image is fast forwarded or fast reversed.	<ul style="list-style-type: none"> ● The picture is slightly disrupted during fast forward and fast reverse operations. 	<ul style="list-style-type: none"> ● This is not a malfunction.
No sound is heard.	<ul style="list-style-type: none"> ● The audio output cords are not properly connected. ● The volume control of the TV or amplifier is not adjusted properly. ● The player is in a special playback mode. 	<ul style="list-style-type: none"> ● Properly connect the audio cords. → ● Set the sound volume to an appropriate level. ● Press the ▶/II key to resume normal playback mode.
The picture does not look good or the picture/sound quality is poor.	<ul style="list-style-type: none"> ● A nearby device is generating noise. ● The disc is dirty. ● The disc is damaged. ● There is condensation on the optical lens. 	<ul style="list-style-type: none"> ● Separate this unit as far as possible from the device you think is generating the noise. ● Refer to the "Disc handling precautions" section and wipe dirt from the disc. → ● Use a new disc. ● Refer to the "Caution on condensation" section and evaporate the condensation. →
It takes a while for the disc to start playing.	<ul style="list-style-type: none"> ● Time is required for the unit to detect the disc type and size and for the rotation of the motor to stabilize. This is not a malfunction. 	<ul style="list-style-type: none"> ● Approximately 10 to 20 seconds are required for a disc to start playing, although the time differs depending on the disc.
The tray opens automatically.	<ul style="list-style-type: none"> ● The disc is not placed horizontally. 	<ul style="list-style-type: none"> ● Properly place the disc on the tray.
The top and bottom of the screen cannot be seen.	<ul style="list-style-type: none"> ● The video format of the disc being played does not match that of the connected TV monitor. 	<ul style="list-style-type: none"> ● Refer to the "Video formats" section, and use a disc with the appropriate video format for your TV or a TV with the appropriate video format for the disc. →
The subtitle is not displayed.	<ul style="list-style-type: none"> ● The DVD disc being played does not contain the recording of subtitles. ● The subtitle mode is set to off. 	<ul style="list-style-type: none"> ● The subtitle cannot be displayed when the DVD disc being played does not contain the recording of subtitles. ● Press the SUBTITLE ON/OFF key to switch on the subtitle mode. →
The voice (or subtitle) language cannot be changed.	<ul style="list-style-type: none"> ● The DVD disc being played does not contain the recording of more than one audio (or subtitle) language. 	<ul style="list-style-type: none"> ● The voice (or subtitle) language cannot be changed when the DVD disc being played does not contain the recording of more than one voice (or subtitle) language.
The viewing angle cannot be changed.	<ul style="list-style-type: none"> ● The DVD disc being played does not contain the recording of more than one angle. ● You are attempting to switch the angle in a DVD section where more than one angle is not recorded. 	<ul style="list-style-type: none"> ● The viewing angle cannot be changed when the DVD disc being played does not contain the recording of more than one angle. ● More than one viewing angle may be recorded only in limited sections in a disc.

DVD player unit

Symptom	Cause	Remedy
Playback will not start even after a title is selected.	<ul style="list-style-type: none"> A viewing restriction (PARENTAL) has been set for the disc. 	<ul style="list-style-type: none"> Check the viewing restriction level (PARENTAL) setting.
The parental level cannot be changed.	<ul style="list-style-type: none"> You have forgotten the password. 	<ul style="list-style-type: none"> Set the initial setup to the factory setup with the following procedure. <ol style="list-style-type: none"> During stop mode, press the MENU key on the remote to enter "Control Panel" menu. Select the "System" icon, then press the Cursor right (▶) key. Select "Restore Setup Info". Press the numeric keys as shown below. Press [1], [3], [9], [7], then press the ENTER key.
The voice or subtitle language selected in the initial setting is not played.	<ul style="list-style-type: none"> The DVD disc being played does not contain the recording of the selected voice or subtitle language. 	<ul style="list-style-type: none"> Use a DVD disc containing the recording of the selected voice or subtitle language.
No message appears on the TV screen after a key is pressed.	<ul style="list-style-type: none"> The function for displaying message on the TV screen (On-Screen Messages) is set to off. 	<ul style="list-style-type: none"> Set On-Screen Messages to on.
Menu screen messages are not shown in the desired language.	<ul style="list-style-type: none"> The menu language function (MENU) is not set. 	<ul style="list-style-type: none"> Set the disc menu language function (MENU) as required.
DVD disc cannot be played.	<ul style="list-style-type: none"> DVD disc cannot be played when the sequential mode of the player is set to "SEQ.2". 	<ul style="list-style-type: none"> Switch it to "SEQ.1". → 
P.B.C.-compatible VCD cannot be played with menu playback.	<ul style="list-style-type: none"> Menu playback is not available when P.B.C. is Off or the sequential play mode of the player is set to "SEQ.2". 	<ul style="list-style-type: none"> Switch it to P.B.C. On or "SEQ.1". →  → 

Remote control unit

Symptom	Cause	Remedy
Remote control operation is not possible.	<ul style="list-style-type: none"> Batteries are exhausted. The remote control is too far away from the system, the controlling angle is deviated or there is an obstacle in between. 	<ul style="list-style-type: none"> Replace with new batteries. Operate the unit inside the remote controllable range.

Inhibition icon

Symptom	Cause	Remedy
 <p>The inhibition icon is displayed and remote control is not possible.</p>	<ul style="list-style-type: none"> Playback is restricted intentionally by the software producer. 	<ul style="list-style-type: none"> The operation is inhibited. Please try another operation.

Apparatus Claims of U.S. Patent Nos. 4,631,603, 4,577,216, 4,819,098 and 4,907,093 licensed for limited viewing uses only.

This product incorporates copyright protection technology that is protected by method claims of certain U.S. patents and other intellectual property rights owned by Macrovision Corporation and other rights owners. Use of this copyright protection technology must be authorized by Macrovision Corporation, and is intended for home and other limited viewing uses only unless otherwise authorized by Macrovision Corporation. Reverse engineering or disassembly is prohibited.

[For U.S.A. and Canada]

Consumers should note that not all high definition television sets are fully compatible with this product and may cause artifacts to be displayed in the picture. In case of 525 progressive scan picture problems, it is recommended that the user switch the connection to the "STANDARD DEFINITION" output. If there are questions regarding our TV set compatibility with this model 525p DVD player, please contact our customer service center.

Manufactured under license from Dolby Laboratories. "Dolby" and the double-D symbol are trademarks of Dolby Laboratories.

"DTS" and "DTS Digital Out" are trademarks of Digital Theater Systems, Inc.



[Type]		[Video Section]	
System	DVD video player	Video output format	NTSC/PAL
Signal read system	Semiconductor laser	Video compression	
Wave length	For DVD; 640 to 660 nm	DVD	MPEG-2
	For CD; 770 to 810 nm	Composite video output level	
Power class	Class 2 (IEC)	1 Vp-p (75 K load, sync. negative)
[D/A Conversion Section]		S-video output level	
D/A conversion	24 Bit	(Y-signal)	1 Vp-p (75 K load, sync. negative)
Oversampling ... 8 fs (Sampling frequency; 44.1, 48 kHz)		(C-signal)	
..... 4 fs (Sampling frequency; 96 kHz)		NTSC	0.286 Vp-p (75 K)
		PAL	0.300 Vp-p (75 K)
[Audio section]		Component Video output level (For U.S.A., CANADA and U.S. Military)	
Frequency response		(Y-signal)	1 Vp-p (75 K)
Sampling frequency ; 44.1 kHz	4 Hz ~ 20 kHz	(Cb-signal)	0.648 Vp-p (75 K)
Sampling frequency ; 48 kHz	4 Hz ~ 22 kHz	(Cr-signal)	0.648 Vp-p (75 K)
Sampling frequency ; 96 kHz	4 Hz ~ 38 kHz	RGB output level (SCART) (For Europe)	0.7 Vp-p (75 K)
Signal to noise ratio	More than 98 dB	Horizontal resolution	More than 480 lines
Dynamic range	More than 92 dB	Video signal to noise ratio	More than 70 dB
Total harmonic distortion	Less than 0.008 % (1 kHz)		
Channel separation	More than 90 dB (1 kHz)	[General]	
Wow and flutter	Below measurable limit	Power consumption	16 W
Analog output level/impedance	2 V / 510 K	Dimensions	W : 440 mm (17-5/16")
Digital output level/impedance			H : 88 mm (3-7/16")
COAXIAL	0.5 Vp-p / 75 K		D : 388 mm (15-1/4")
OPTICAL	-21 dBm ~ -15 dBm (Wave length 660 nm)	Weight (net)	5.3 kg (11.7 lb)

 **KENWOOD follows a policy of continuous advancements in development. For this reason specifications may be changed without notice.**

- Sufficient performance may not be exhibited at extremely cold locations (Where water freezes).

KENWOOD

For your records

Record the serial number, found on the back of the unit, in the spaces designated on the warranty card, and in the space provided below. Refer to the model and serial numbers whenever you call upon your dealer for information or service on this product.

Model _____ Serial Number _____